



Operating Instructions

MCA 122 Modbus TCP

Safety

Safety

Copyright, Limitation of Liability and Revision Rights

This publication contains information proprietary to Danfoss. By accepting and using this manual the user agrees that the information contained herein is used solely for operating equipment from Danfoss or equipment from other vendors if such equipment is intended for communication with Danfoss equipment over an Ethernet serial communication link. This publication is protected under the Copyright laws of Denmark and most other countries.

Danfoss does not guarantee that a software program produced according to the guidelines provided in this manual functions properly in every physical, hardware, or software environment.

Although Danfoss has tested and reviewed the documentation within this manual, Danfoss makes no warranty or representation, either express or implied, with respect to this documentation, including its quality, performance, or fitness for a particular purpose.

In no event shall Danfoss be liable for direct, indirect, special, incidental, or consequential damages arising out of the use, or the inability to use information contained in this manual, even if advised of the possibility of such damages. In particular, Danfoss is not responsible for any costs including but not limited to the damages incurred as a result of lost profits or revenue, loss or damage of equipment, loss of computer programs, loss of data, the costs to substitute these, or any claims by third parties.

Danfoss reserves the right to revise this publication at any time and change its contents without prior notice or any obligation to notify previous users of such revisions or changes.

Safety Note

▲WARNING

HIGH VOLTAGE

The voltage of the frequency converter is dangerous whenever connected to mains. Incorrect installation of the motor, frequency converter, or fieldbus may damage the equipment, cause serious personal injury, or death. Consequently, the instructions in this manual, as well as national and local rules and safety regulations, must be complied with.

Safety Regulations

1. The frequency converter must be disconnected from mains before carrying out repair work. Check that the mains supply has been disconnected and that the necessary time has passed before removing motor and mains plugs.
2. The off-command on the serial bus does not disconnect the equipment from mains and should not be used as a safety switch.
3. Correct protective earthing or grounding of the equipment must be established. The user must be protected against supply voltage, and the motor must be protected against overload in accordance with applicable national and local regulations.
4. The earth leakage currents are higher than 3.5 mA.
5. Do not remove the plugs for the motor and mains supply while the frequency converter is connected to mains. Check that the mains supply has been disconnected and that the necessary time has passed before removing motor and mains plugs.

Warning against Unintended Start

1. The motor can be brought to a stop with bus commands while the frequency converter is connected to mains. These stop functions do NOT provide protection against unintended starts.
2. While parameters are being changed, there is a risk that motor starts.
3. Electronic faults in the frequency converter and cease of
 - temporary overload
 - faults in supply mains, or
 - fault in the motor connection

can cause an unintended start.

WARNING

ELECTRICAL HAZARD

Touching the electrical parts may be fatal - even after the equipment has been disconnected from mains.

Contents

1 Introduction	3
1.1 Introduction	3
1.1.1 About this Manual	3
1.1.2 Assumptions	3
1.1.3 Background Knowledge	3
1.1.4 Available Literature	3
1.1.5 Modbus Conformance	3
1.1.6 Abbreviations	4
2 How to Install	5
2.1 The Modbus TCP Option	5
2.1.1 How to Install Option in Frequency Converter	5
2.1.2 LED Behaviour	6
2.1.3 Topology	7
2.1.4 Network	8
2.1.5 Recommended Design Rules	8
2.1.6 EMC Precautions	10
3 How to Configure	11
3.1 IP Settings	11
3.2 Ethernet Link Parameters	11
3.3 Configuring the Scanner	12
3.4 IP Traffic	15
4 How to Control	17
4.1 How to Control the Frequency Converter	17
4.1.1 Function Codes Supported by Modbus TCP	17
4.2 Modbus TCP Message Framing Structure	17
4.2.1 Function Code	17
4.2.2 Data Field	17
4.2.3 Parameter Handling	17
4.2.4 Storage of Data	17
4.2.5 IND	18
4.2.6 Text Blocks	18
4.2.7 Conversion Factor	18
4.2.8 Parameter Values	18
4.2.9 Modbus Exception Codes	18
4.3 PROFIdrive Control Profile	19
4.3.1 Control Word according to PROFIdrive Profile (CTW)	19
4.3.2 Status Word according to PROFIdrive Profile (STW)	20

4.3.3 PROFIdrive State - Transition Diagram	21
4.4 Danfoss FC Control Profile	23
4.4.1 Status Word according to Frequency Converter Profile (STW)	24
4.5 Reference Handling	25
4.5.1 Bus Speed Reference Value	25
5 Parameters	27
5.1 Parameter Group 8-**	27
5.2 Parameter Group 12-**	30
5.2.1 12-0* IP Settings	30
5.2.2 12-1* Ethernet Link Parameters	31
5.2.3 12-2* Process Data	32
5.2.4 Modbus TCP	32
5.2.5 12-8* Other Ethernet Services	33
5.2.6 12-9* Advanced Ethernet Settings	33
5.3 Parameter List	34
5.4 Data Types	36
5.4.1 Data Types Supported by FC 102/FC 202/FC 302	36
6 Troubleshooting	37
6.1 Step-by-step Troubleshooting	37
6.2 Alarm Word and Warning Word	37
Index	41

1 Introduction

1.1 Introduction

1.1.1 About this Manual

First time users can find the most essential information for quick installation and set-up in these chapters:

- 1 Introduction
- 2 How to Install
- 3 How to Configure

For more detailed information including the full range of set-up options and diagnosis tools, refer to the chapters:

- 3 How to Configure
- 4 How to Control
- 5 Parameters
- 6 Troubleshooting

Terminology

Ethernet is a common term used to describe the physical layer of the network and does not relate to the application protocol.

1.1.2 Assumptions

These operating instructions are under the conditions that the MCA 122 Modbus TCP option is used with a Danfoss FC 100/FC 202/FC 300 frequency converter, and that the installed option supports the interfaces described in this document and that all the requirements stipulated in the option, as well as the frequency converter, are strictly observed along with all limitations herein.

1.1.3 Background Knowledge

The Danfoss Modbus Option Card is designed to communicate with any system complying with the Modbus Messaging on TCP/IP Implementation Guide V1.0b and Modbus Application Protocol Specification V1.1b standard. Familiarity with this technology is assumed. Issues regarding hardware or software produced by other manufacturers, including commissioning tools, are beyond the scope of this manual, and are not the responsibility of Danfoss.

For information regarding commissioning tools, or communication to a non-Danfoss node, consult the appropriate manuals.

1.1.4 Available Literature

Available Literature for FC 102/FC 202/FC 300

- The Operating Instructions for VLT® HVAC Drive FC 102, VLT® AQUA Drive FC 202 and VLT® AutomationDrive FC 302 provide the necessary information for getting the frequency converter up and running.
- The Design Guides for VLT® HVAC Drive FC 102, VLT® AQUA Drive FC 202 and VLT® AutomationDrive FC 302 entail all technical information about the frequency converter design and applications including encoder, resolver, and relay options.
- The VLT® AutomationDriveFC 302 Profibus Operating Instructions, provide the information required for controlling, monitoring, and programming the frequency converter via a Profibus Fieldbus.
- The VLT® AutomationDriveFC 302 Operating Instructions, provide the information required for controlling, monitoring, and programming the frequency converter via a DeviceNet Fieldbus.
- The MCT 10 Set-up Software Operating Instructions, provide information for installation and use of the software on a PC.
- The VLT® AutomationDriveFC 302 IP21/Type 1 Instruction, provides information for installing the IP21/Type 1 option.
- The VLT® AutomationDriveFC 302 24 V DC Backup Instruction, provides information for installing the 24 V DC Backup option.

Danfoss technical literature is also available online at www.danfoss.com/BusinessAreas/DrivesSolutions/Documentations/Technical+Documentation.htm.

1.1.5 Modbus Conformance

The Modbus option is tested to conform to the Modbus standards and is certified towards conformance test level version 3.

1.1.6 Abbreviations

1

Abbreviation	Definition
API	Actual Packet Interval
CC	Control Card
CIP	Common Industrial Protocol
CTW	Control Word
DHCP	Dynamic Host Configuration Protocol
EMC	Electromagnetic Compatibility
I/O	Input/Output
IP	Internet Protocol
LCP	Local Control Panel
LED	Light Emitting Diode
LSB	Least Significant Bit
MAR	Major Recoverable fail
MAU	Major Unrecoverable fail
MAV	Main Actual Value (actual output)
MSB	Most Significant Bit
MRV	Main Reference Value
N/A	Not applicable
ODVA	Open DeviceNet Vendor Association
PC	Personal Computer
PLC	Programmable Logic Controller
PNU	Parameter Number
REF	Reference (=MRV)
RTC	Real Time Clock
s	Second
STP	Spanning tree Protocol
STW	Status Word

Table 1.1 Abbreviations

2 How to Install

2.1 The Modbus TCP Option

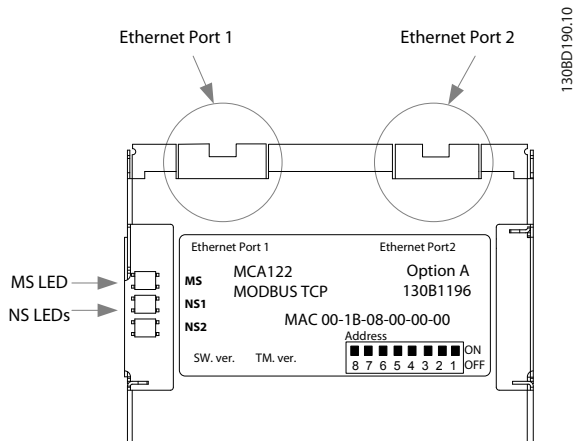

Illustration 2.1 Overview of the Option

2.1.1 How to Install Option in Frequency Converter

Items required for installing a fieldbus option in the frequency converter

- The fieldbus option
- Fieldbus option adapter frame for the FC 102/FC 202/FC 300. This frame is deeper than the standard frame, to allow space for the fieldbus option beneath
- Strain relief (only for A1 and A2 enclosures)

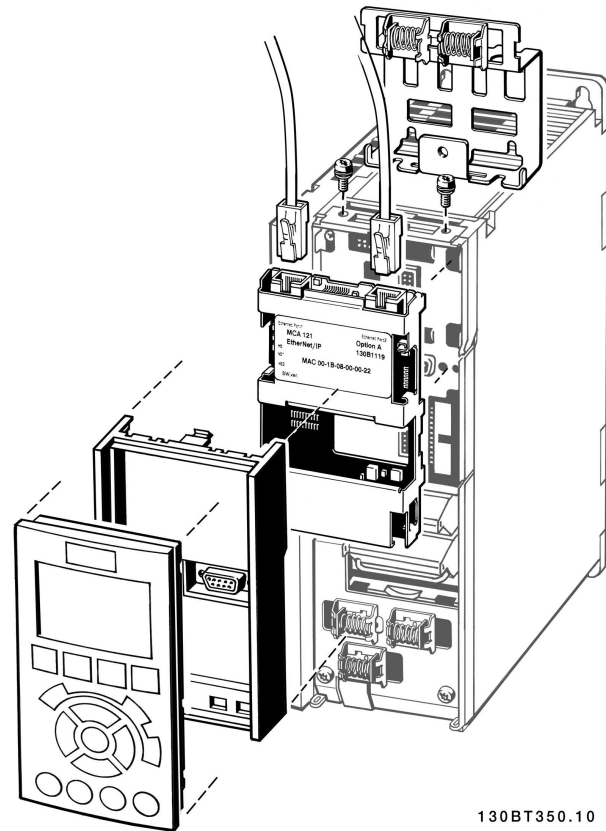

Illustration 2.2 Option Installed in Frequency Converter

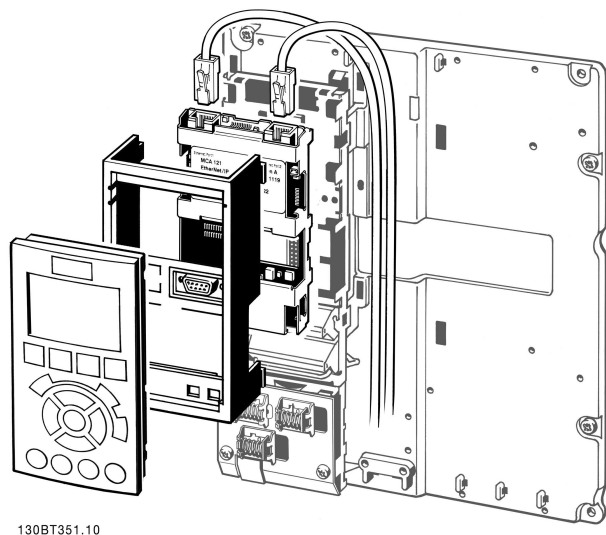

Illustration 2.3 Strain Relief for Enclosure Types A1 and A2

Instructions

1. Remove LCP panel from the frequency converter.
2. Remove the frame located beneath and discard it.
3. Push the option into place. The Ethernet connectors must be facing upwards.
4. Remove both knock-outs on the fieldbus option adapter frame.
5. Push the fieldbus option adapter frame for the frequency converter into place.
6. Replace the LCP and attach cable.

NOTICE

After installing the MCA 122 option, be aware of the following parameter settings:

8-01 Control Site: [2] control word only or [0] Digital and ctrl. word

8-02 Control Word Source: [3] Option A

NOTICE

Do not strip the Ethernet cable and ground it via the strain relief-plate! The grounding of screened Ethernet cable is done through the RJ-45 connector on the option.

2.1.2 LED Behaviour

The option has three bi-coloured LEDs

LED label	Description
MS	Module Status
NS1	Network Status Ethernet Port 1
NS2	Network Status Ethernet Port 2

Table 2.1 Description of LEDs

State	LED		Description
No power		Off	The device is un-powered
Device operational	Green:	Solid green	The device is operational
Standby	Green:	Flashing green	The device needs commissioning
Minor fault	Red:	Flashing red	The device has detected a recoverable fault
Major fault	Red:	Solid red	The device has detected an un-recoverable fault
Self test	Red:	Flashing red/ green	The Modbus TCP option is in self-test mode
	Green:		
No IP address	Yellow	Steady yellow	No IP address configured or obtained
Wink	Yellow	Flashing yellow	Flash for 20 s

Table 2.2 MS: Module Status

State	LED		Description
No IP-address (no power)		Off	No link present (or is un-powered)
Connected	Green:	Solid green	Link present; but nor winked and no ACD
Duplicate IP	Red:	Solid red	The IP-address assigned to the device is already in use
Self test	Red:	Flashing red/ green	The Modbus TCP is in self-test mode
	Green:		
Device has been winked	Yellow	Flashing yellow	Flash for 20 s
Link present at 10 Mbps	Yellow	Steady yellow	Link present; but nor winked and no ACD

Table 2.3 NS1+NS2: Network Status (One per Port)

2.1.3 Topology

The MCA 122 features a built-in Ethernet-switch, thus having two Ethernet RJ-45 connectors. This enables the possibility for connecting several Modbus TCP options in a line topology as an alternative to the typical star-topology.

The two ports are equal, in the sense that they are transparent for the option. If only one connector is used, either port can be used.

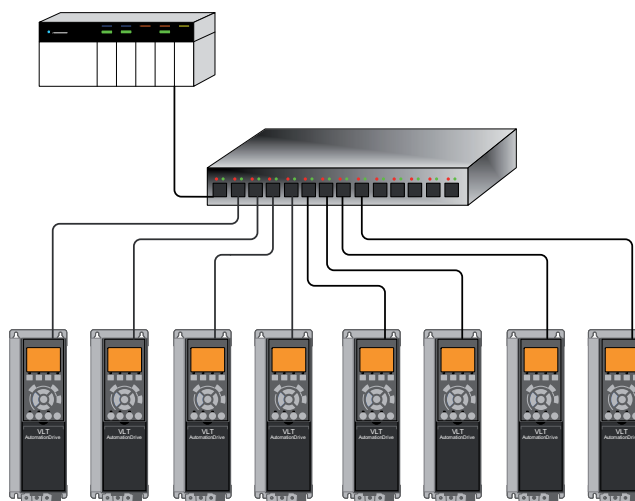

130BA903.10

Illustration 2.4 Star Topology

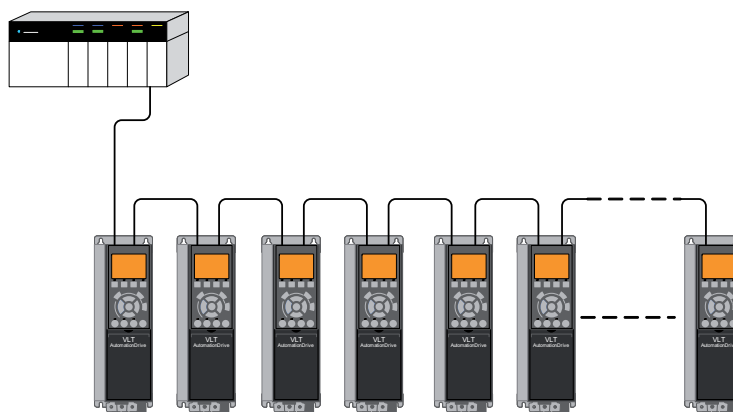

130BA904.10

Illustration 2.5 Line Topology

NOTICE

For line topology, refer to 2.1.5 Recommended Design Rules. In a line topology all frequency converters must be powered, either by mains or by their 24 V DC option cards, for the built-in switch to work.

NOTICE

Observe that mounting frequency converters of different power-sizes in a line topology may result in unwanted power-off behaviour.

Smaller frequency converters discharge faster than bigger frequency converters. This can result in loss of link in the line topology, which may lead to control word timeout.

To avoid this, mount the frequency converters with the longest discharge time first in the line topology.

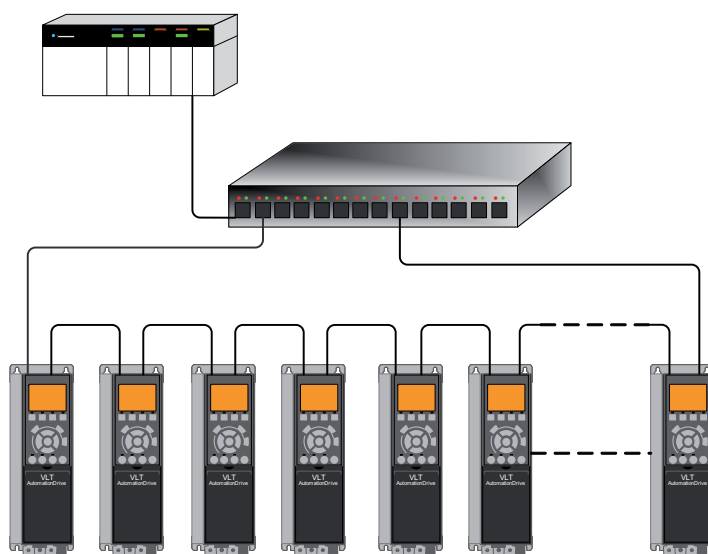

130BA905.10

Illustration 2.6 Ring/Redundant Line Topology

2.1.4 Network

It is of high importance that the media chosen for Ethernet data transmission are suitable. Usually CAT 5e and six cables are recommended for industrial applications. Both types of cable are available as Unshielded Twisted Pair and Shielded Twisted Pair. Shielded cables are recommended for use in industrial environments and with frequency converters.

A maximum cable-length of 100 m is allowed between switches.

Optical fibres can be used for gapping longer distances and providing galvanic isolation.

For connecting Modbus TCP devices both hubs and switches can be used. It is, however, always recommended to use suitable industrial graded Ethernet switches. For

more information regarding IP-switching, refer to 3.4.1 *IP Traffic*.

2.1.5 Recommended Design Rules

While designing Ethernet networks special attention and caution must be taken regarding active network components.

While designing a network for line topology it is important to notice that a small delay is added with each every switch in the line.

It is not recommended to connect more than 32 frequency converters in a line at any API. Exceeding the recommended design rules, may result in failing communication.

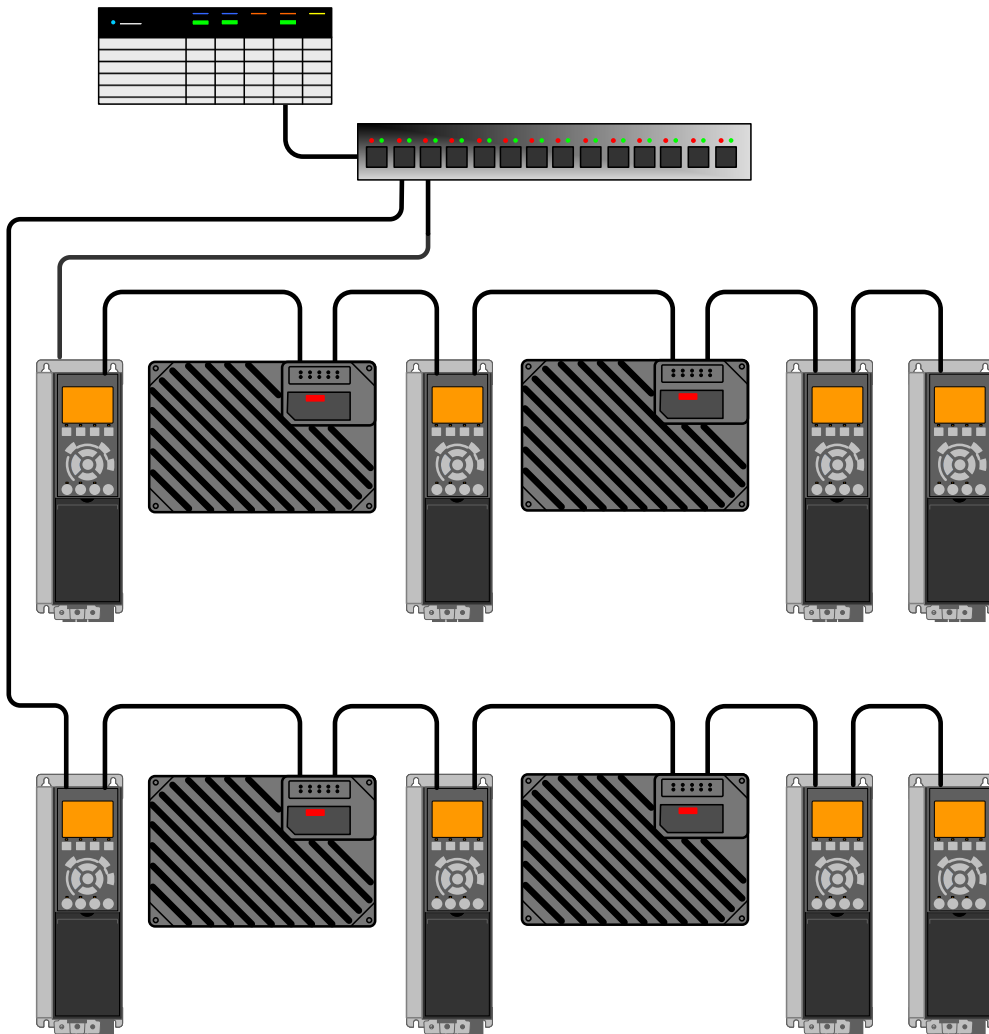

Illustration 2.7

2.1.6 EMC Precautions

NOTICE

Relevant national and local regulations, for example regarding protective earth connection, must be observed.

For interference-free operation of the Ethernet network, take the following EMC precautions.

- Keep the Ethernet communication cable away from motor and brake resistor cables to avoid

coupling of high frequency noise from one cable to another

- Maintain the greatest possible distance (min. 200 mm (8 inches)) between cables. Especially, where cables run in parallel over long distances.
- If crossing is unavoidable, the Ethernet cable must cross motor and brake resistor cables at an angle of 90°

Additional EMC information is available in the frequency converter Design Guide.

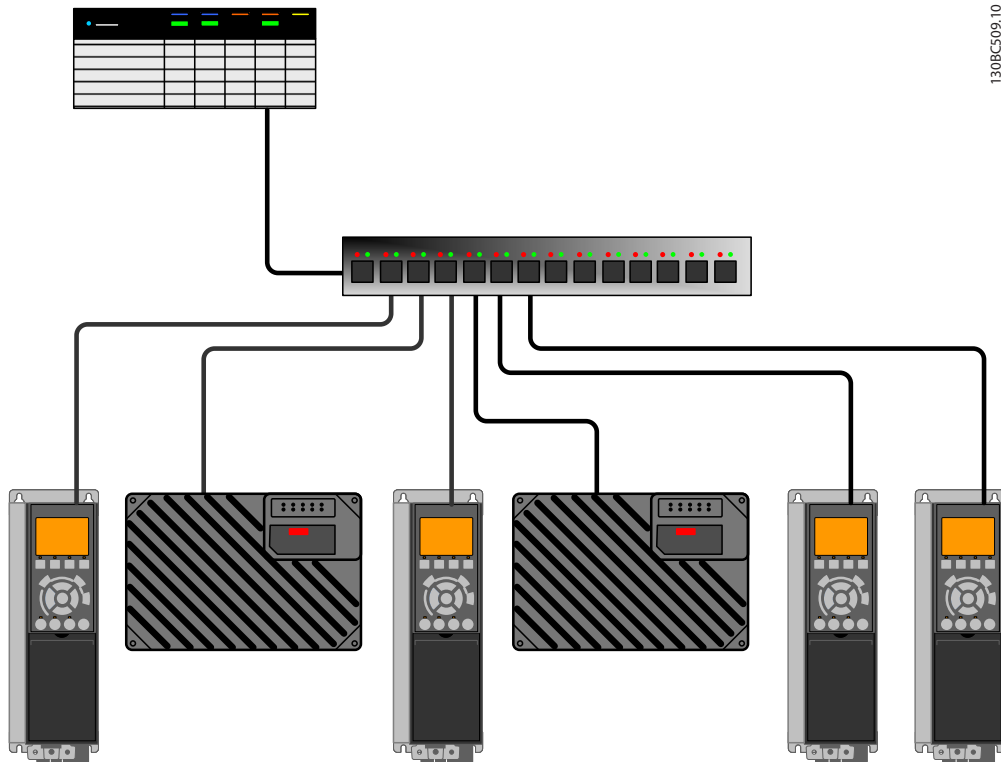

1308C509.10

Illustration 2.8 EMC-correct Installation

3 How to Configure

3.1 IP Settings

All IP-related parameters are located in parameter group 12-0* IP Settings:

- 12-00 IP Address Assignment
- 12-01 IP Address
- 12-02 Subnet Mask
- 12-03 Default Gateway
- 12-04 DHCP Server
- 12-05 Lease Expires
- 12-06 Name Servers
- 12-07 Domain Name
- 12-08 Host Name
- 12-09 Physical Address

The MCA 122 option offers several ways of IP address assignment.

Setting up the frequency converter with manually assigned IP address

Parameter	Value
12-00 IP Address Assignment	[0] MANUAL
12-01 IP Address	192.168.0.xxx*
12-02 Subnet Mask	255.255.255.0*
12-03 Default Gateway	optional

Table 3.1 Assigning IP Addresses Manually

*= Class C IP address example. Any valid IP address can be entered.

NOTICE

A power-cycle is necessary after setting the IP parameters manually.

Setting up the frequency converter with automatically (BOOTP/DHCP) assigned IP address

Parameter	Value
12-00 IP Address Assignment	[1] DHCP/[2] BOOTP
12-01 IP Address	Read only
12-02 Subnet Mask	Read only
12-03 Default Gateway	Read only

Table 3.2 Assigning IP Addresses Automatically

By IP address assigned by DHCP/BOOTP server, the assigned IP Address and Subnet Mask can be read out in 12-01 IP Address and 12-02 Subnet Mask. In 12-04 DHCP

Server DHCP Server, the IP address of the found DHCP or BOOTP server is displayed.

For DHCP only: The remaining lease-time can be read-out in 12-05 Lease Expires Lease Expires.

12-09 Physical Address, Physical Address reads out the MAC address of option, which is also printed on the label of the option. If using fixed leases together with DHCP or BOOTP, the physical MAC address is linked with a fixed IP address.

NOTICE

If no DHCP or BOOTP reply has been received after four attempts (for example, if the DHCP/BOOTP server has been powered off), the option will fallback to the last good known IP address.

12-03 Default Gateway, Default Gateway is optional and only used in routed networks.

12-06 Name Servers, Name Servers

12-07 Domain Name, Domain Name

12-08 Host Name, Host Name

are used with Domain Name Server systems and are all optional. If DHCP or BOOTP is selected as IP address assignment, these parameters are read only.

NOTICE

It is only possible to assign valid class A, B, and C IP address to the option. The valid ranges are shown in Table 3.3.

Class A	1.0.0.1 - 126.255.255.254
Class B	128.1.0.1 - 191.255.255.254
Class C	192.0.1.1 - 223.255.254.254

Table 3.3 Valid Ranges of IP Addresses

3.2 Ethernet Link Parameters

Parameter group 12-1* Ethernet Link Parameters holds information Ethernet Link information:

- 12-10 Link Status
- 12-11 Link Duration
- 12-12 Auto Negotiation
- 12-13 Link Speed
- 12-14 Link Duplex

NOTICE

The Ethernet Link Parameters are unique per port.

12-10 Link Status and 12-11 Link Duration displays information on the link status, per port.

12-10 Link Status displays Link or No Link according to the status of the present port.

12-11 Link Duration displays the duration of the link on the present port. If the link is broken the counter resets.

12-12 Auto Negotiation – is a feature that enables two connected Ethernet devices to choose common transmission parameters, such as speed and duplex mode. In this process, the connected devices first share their capabilities as for these parameters and then choose the fastest transmission mode they both support.

By default this function is enabled.

Incapability between the connected devices, may lead to decreased communication performance.

To prevent this, Auto Negotiation can be disabled.

If 12-12 Auto Negotiation is set to OFF, link speed and duplex mode can be configured manually in 12-13 Link Speed and 12-14 Link Duplex.

12-13 Link Speed – displays/sets the link speed per port. “None” is displayed if no link is present.

12-14 Link Duplex – displays/sets the duplex mode per port.

Half-duplex provides communication in both directions, but only in one direction at a time (not simultaneously).

Full-duplex allows communication in both directions, and unlike half-duplex, allows for communication in both directions, to happen simultaneously.

3.3 Configuring the Scanner

For configuring the scanner to communicate to the frequency converter, no system (for example, EDS, GSD file) file is needed. The frequency converter is handled as a generic device and as such, configured directly in the scanner. The following example sets up the scanner to IP addresses 192.168.1.20 and the FC 302 to address 192.168.1.20.

Configuring a Modicon scanner

The following example uses the Unity Pro tool from Group Schneider to configure the PLC. The example only shows the setting up of the Protocol and assigning I/O mapping to internal memory of the PLC.

Under network, add a network by right clicking the Network menu and select “New Network”

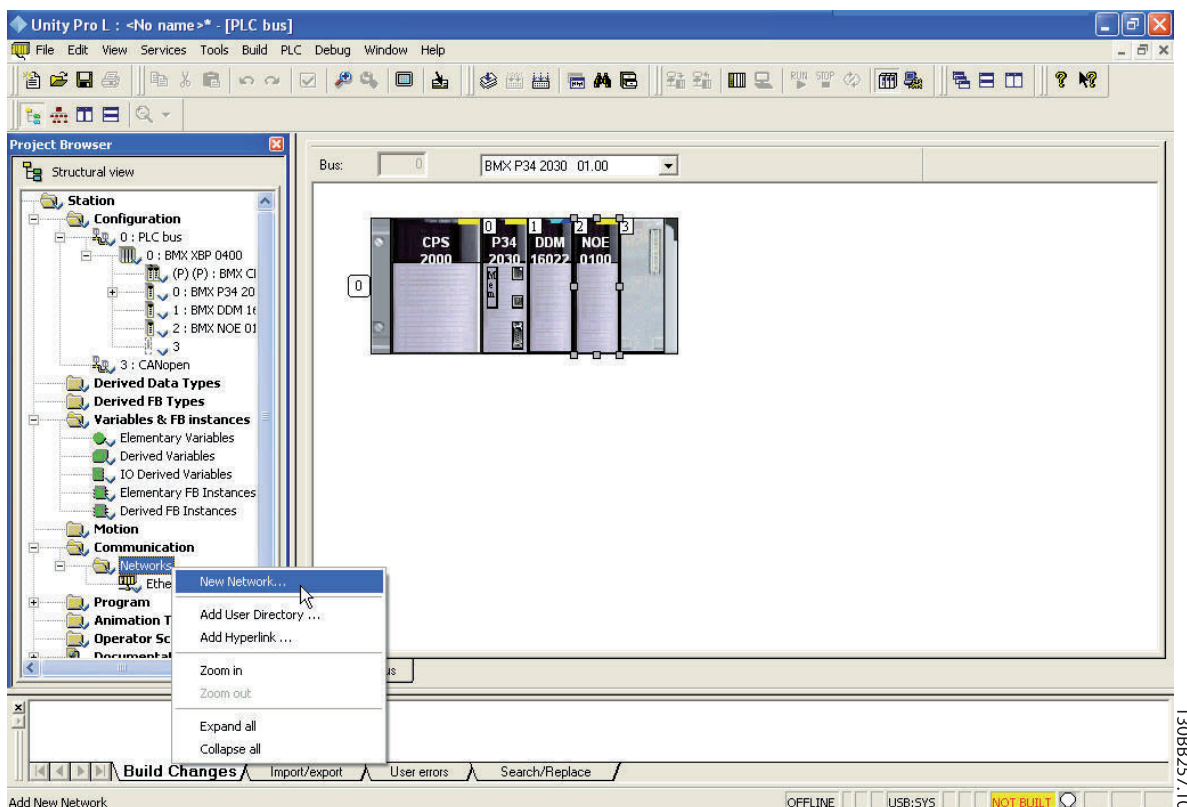

Illustration 3.1 Adding a Network

By selecting this menu, assign a name to the new network. In this example “Danfoss” has been chosen.

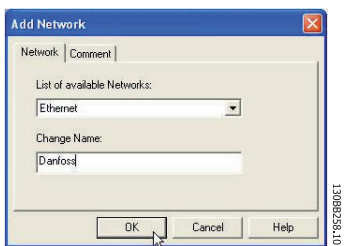

Illustration 3.2 Assigning a Network Name

After clicking [OK], the network “Danfoss” should show up under Networks and by selecting the Network, the main configuration page is shown.

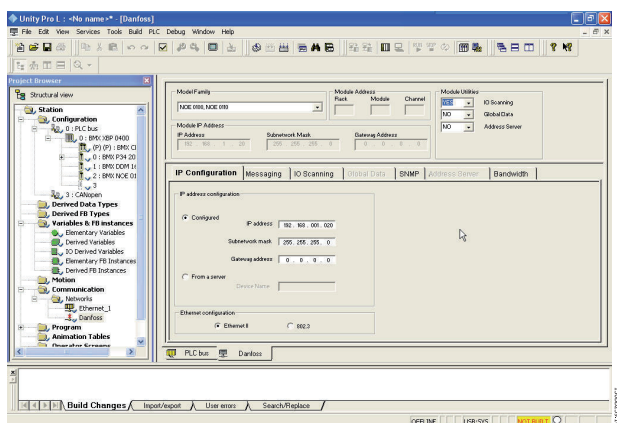

Illustration 3.3 Main Configuration Page

Menu	Menu point	Setting
Model Family	Model Family	NOE 0100, NOE 110
Model Utilities	IO Scanning	YES
	Global Data	NO
	Address Server	NO
IP address configuration	Configured/From a server	Configured
	IP address	192.168.001.020
	Subnetwork mask	255.255.255.0
	Gateway address	0.0.0.0
Ethernet Configuration	Ethernet Configuration	Ethernet II

Table 3.4 Menu Settings

In the IP Configuration tab, press the [Configured] key, and the IP address and fill out [Subnetwork mask]. In this example the address 192.168.1.20 is used as the address for the master.

The step assigns the protocol to the scanner, which is done by selecting the scanner and selecting the “Function” menu and enables the Ethernet by selecting “ETH TCP IP” This brings up the Net Link menu, where “Danfoss” has to be selected. At this time, the “Danfoss” Protocol is assigned to the Scanner and the last step is to configure the scanner to read and write holding registers of the FC 302.

3

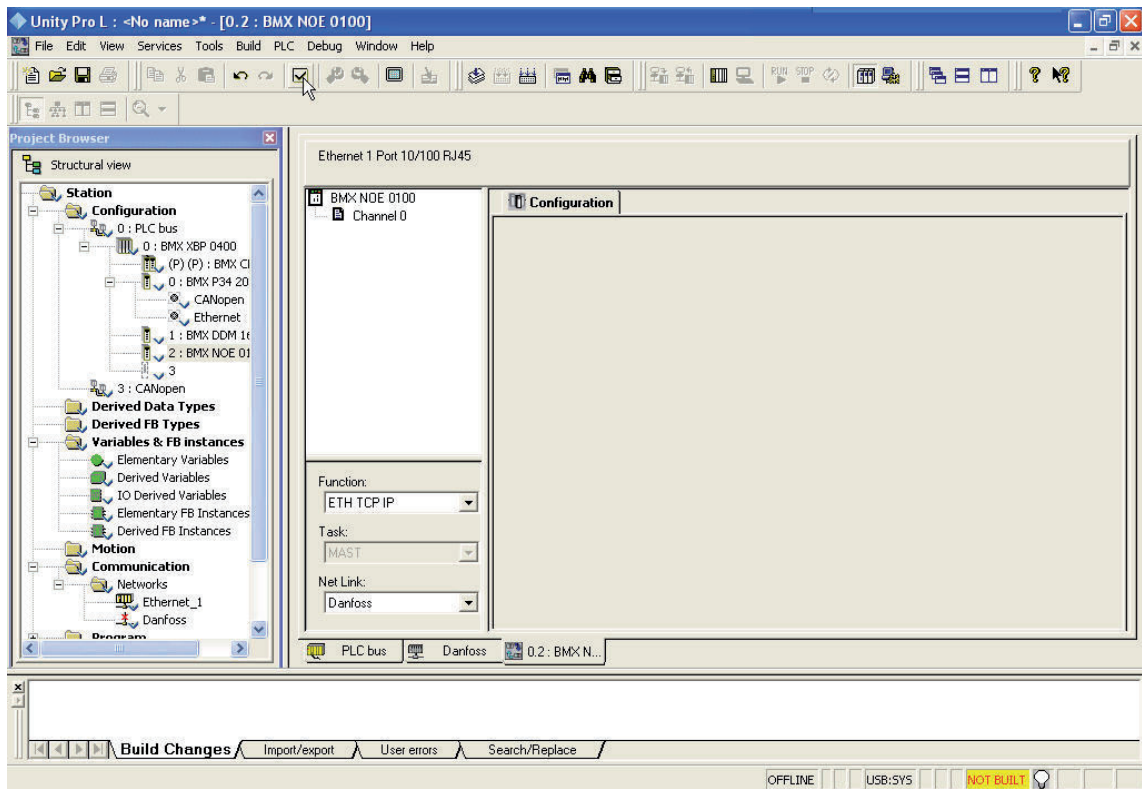

Illustration 3.4 Net Link Menu

Menu	Menu point	Setting
Function	Function	ETH TCP IP
Net Link	Net Link	Danfoss

Table 3.5 Menu Settings

At this time the “Danfoss” Protocol is assigned to the Scanner and the last step is to configure the scanner to read and write holding registers of the FC 302.

By first selecting the Danfoss network and second, selecting the IO Scanning tab, the scanning list appears. Fill out the list as shown in *Illustration 3.5*.

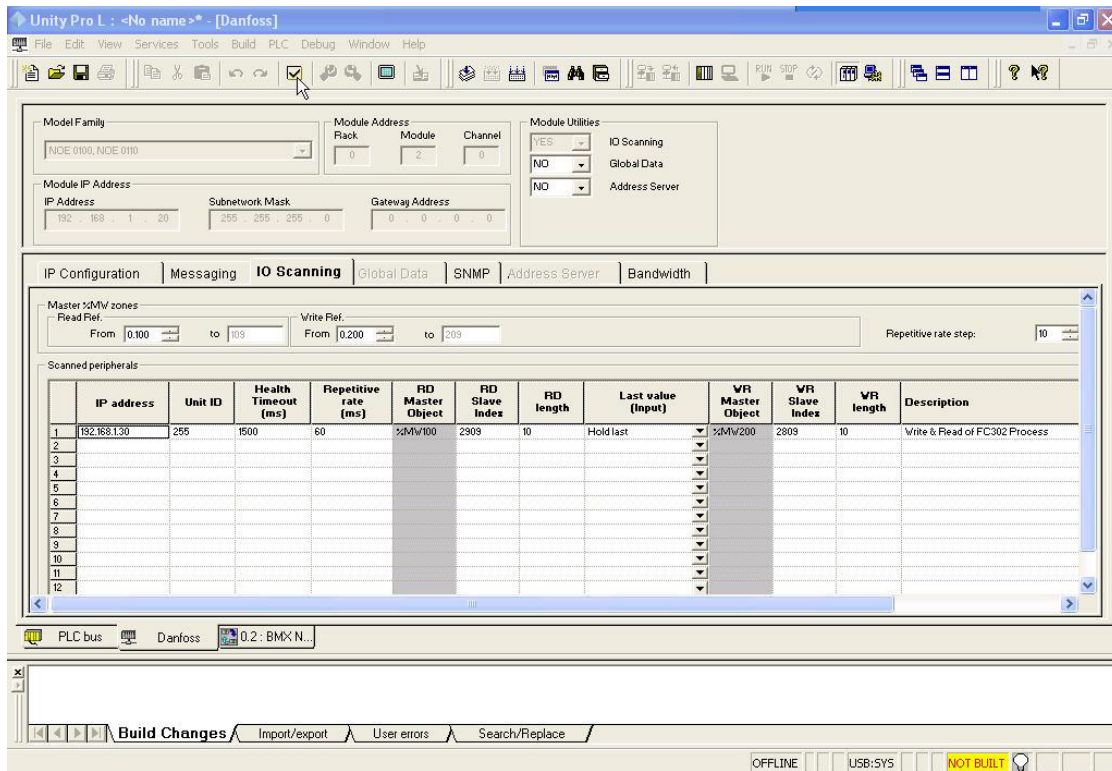

130BB261.11

3

Illustration 3.5 Scanning List

Menu	Menu point	Setting
IO Scanning	IP address	192.168.001.030
	Unit ID	255
	Health Timeout	1500
	Repetitive rate	60
	RD Master Object	%MW100
	RD Slave Index	2910
	RD Length	10
	Last Value	Hold Last
	VR Master Object	%MW200
	VR Slave Index	2810
	VR Length	10
	Description	-

Table 3.6 Menu Settings

This configuration copies the information stored from %MW200 to %M209 in the PLC to the Holding register 2810 to 2819 of the FC 302. It reads the holding registers 2910 to 2919 of the FC 302 to the PLCs memory %MW100 to %M109.

3.4 IP Traffic

The use of Ethernet-based network for industrial automation purposes, calls for careful and thorough network design. Especially the use of active network components like switches and routers requires detailed know-how about the behaviour of IP traffic.

Some important issues

IGMP

IGMP (Internet Group Management Protocol) is an integrated part of IP. It allows hosts to join or leave a multicast host group. Group membership information is exchanged between a specific host and the nearest multicast router.

Spanning Tree Protocol (STP)

For an Ethernet network to function properly, only one active path can exist between two nodes. Spanning-Tree Protocol is a link management protocol that provides path redundancy while preventing undesirable loops in the network.

When loops occur, some switches see stations appearing on both sides of them. This condition confuses the forwarding algorithm and allows for duplicate frames to be forwarded.

To provide path redundancy, Spanning-Tree Protocol defines a tree that spans all switches in an extended network. Spanning-Tree Protocol forces certain redundant data paths into a standby (blocked) state. If one network segment in the Spanning-Tree Protocol becomes unreachable, or if Spanning-Tree Protocol costs change, the spanning-tree algorithm reconfigures the spanning-tree topology and reestablishes the link by activating the standby path.

Spanning-Tree Protocol operation is necessary if the frequency converters are running in a ring/redundant line topology.

4 How to Control

4.1 How to Control the Frequency Converter

This section describes codes which can be used in the function and data fields of a Modbus TCP message. For a complete description of all the message fields, refer to *4.2 Modbus TCP Message Framing Structure*.

4.1.1 Function Codes Supported by Modbus TCP

Modbus TCP supports use of the following function codes in the function field of a message

Function	Function code
Read holding registers	3 hex
Write single register	6 hex
Write multiple registers	10 hex
Get comm. event counter	B hex
Report slave ID	11 hex
Read/Write multiple registers	17 hex

Table 4.1 Function Codes

Function	Function code	Sub-function code	Sub-function
Diagnostics	8	1	Restart communication
		2	Return diagnostic register
		10	Clear counters and diagnostic register
		11	Return bus message count
		12	Return bus communication error count
		13	Return bus exception error count
		14	Return slave message count

Table 4.2 Subfunction Codes

4.2 Modbus TCP Message Framing Structure

4.2.1 Function Code

The function code of a message frame contains 8 bits. Valid codes are in the range of 1-FF. Use function codes to send messages between master and slave. When a message is sent from a master to a slave device, the

function code tells the slave what action to perform. When the slave responds to the master, it uses the function code to indicate either a normal (error-free) response, or that some error occurred (called an exception response). For a normal response, the slave echoes the original function code. For an exception response, the slave returns a code that is equivalent to the original function code with its most significant bit set to logic 1. In addition, the slave places a unique code into the data field of the response message. This tells the master what error occurred, or the reason for the exception. Refer also to sections *4.1.1 Function Codes Supported by Modbus TCP* and *4.2.9 Modbus Exception Codes*.

4.2.2 Data Field

The data field is constructed using sets of two hexadecimal digits, in the range of 00 to FF hexadecimal. These digits are made up of one TCP character. The data field of messages sent from a master to slave device contains additional information which the slave must use to take the action defined by the function code. This can include items such as coil or register addresses, the quantity of items to be handled, and the count of actual data bytes in the field.

4.2.3 Parameter Handling

The PNU (Parameter Number) is translated from the register address contained in the Modbus read or write message. The parameter number is translated to Modbus as (10 x parameter number) DECIMAL. Example: Reading *3-12 Catch up/slow Down Value* (16bit): The holding register 3120 holds the parameters value. A value of 1352 (Decimal), means that the parameter is set to 12.52%

Reading *3-14 Preset Relative Reference* (32bit): The holding registers 3410 & 3411 holds the parameters value. A value of 11300 (Decimal), means that the parameter is set to 1113.00 S.

For information on the parameters, size and converting index, consult the product relevant programming guide.

4.2.4 Storage of Data

The Coil 65 decimal determines whether data written to the frequency converter are stored in EEPROM and RAM (coil 65=1) or only in RAM (coil 65= 0).

4.2.5 IND

Some parameters in the frequency converter are array parameters e.g. *3-10 Preset Reference*. Since the Modbus does not support arrays in the Holding registers, the frequency converter has reserved the Holding register 9 as pointer to the array. Before reading or writing an array parameter, set the holding register 9. Setting holding register to the value of 2, will cause all following read/write to array parameters to be to the index 2.

4.2.6 Text Blocks

Parameters stored as text strings are accessed in the same way as the other parameters. The maximum text block size is 20 characters. If a read request for a parameter is for more characters than the parameter stores, the response is truncated. If the read request for a parameter is for fewer characters than the parameter stores, the response is space filled.

4.2.7 Conversion Factor

The different attributes for each parameter can be seen in the section on factory settings. Since a parameter value can only be transferred as a whole number, a conversion factor must be used to transfer decimals.

4.2.8 Parameter Values

Standard data types

Standard data types are int16, int32, uint8, uint16 and uint32. They are stored as 4x registers (40001–4FFFF). The parameters are read using function 03HEX "Read Holding Registers." Parameters are written using the function 6HEX "Preset Single Register" for 1 register (16 bits), and the function 10 HEX "Preset Multiple Registers" for 2 registers (32 bits). Readable sizes range from 1 register (16 bits) up to 10 registers (20 characters).

Non standard data types

Non standard data types are text strings and are stored as 4x registers (40001–4FFFF). The parameters are read using function 03HEX "Read Holding Registers" and written using function 10HEX "Preset Multiple Registers." Readable sizes range from 1 register (2 characters) up to 10 registers (20 characters).

4.2.9 Modbus Exception Codes

For a full explanation of the structure of an exception code response, refer to *4.2 Modbus TCP Message Framing Structure*.

Code	Name	Meaning
1	Illegal function	The function code received in the query is not an allowable action for the server (or slave). This may be because the function code is only applicable to newer devices, and was not implemented in the unit selected. It could also indicate that the server (or slave) is in the wrong state to process a request of this type, for example because it is not configured and is being asked to return register values.
2	Illegal data address	The data address received in the query is not an allowable address for the server (or slave). More specifically, the combination of reference number and transfer length is invalid. For a controller with 100 registers, a request with offset 96 and length 4 would succeed, a request with offset 96 and length 5 generates exception 02.
3	Illegal data value	A value contained in the query data field is not an allowable value for server (or slave). This indicates a fault in the structure of the remainder of a complex request, such as that the implied length is incorrect. It specifically does NOT mean that a data item submitted for storage in a register has a value outside the expectation of the application program, since the Modbus protocol is unaware of the significance of any particular value of any particular register.
4	Slave device failure	An unrecoverable error occurred while the server (or slave) was attempting to perform the requested action.

Table 4.3 Modbus Exception Codes

4.3 PROFIdrive Control Profile

This section describes the functionality of the control word and status word in the PROFIdrive profile. Select this profile by setting *8-10 Control Word Profile*.

4.3.1 Control Word according to PROFIdrive Profile (CTW)

The Control word is used to send commands from a master (for example, a PC) to a slave.

Bit	Bit=0	Bit=1
00	OFF 1	ON 1
01	OFF 2	ON 2
02	OFF 3	ON 3
03	Coasting	No coasting
04	Quick stop	Ramp
05	Hold frequency output	Use ramp
06	Ramp stop	Start
07	No function	Reset
08	Jog 1 OFF	Jog 1 ON
09	Jog 2 OFF	Jog 2 ON
10	Data invalid	Data valid
11	No function	Slow down
12	No function	Catch up
13	Parameter set-up	Selection lsb
14	Parameter set-up	Selection msb
15	No function	Reverse

Table 4.4 Control Word Bits

Explanation of the control bits

Bit 00, OFF 1/ON 1

Normal ramp stops using the ramp times of the actual selected ramp.

Bit 00="0" leads to the stop and activation of the output relay 1 or 2 if the output frequency is 0 Hz and if [Relay 123] has been selected in *5-40 Function Relay*.

When bit 0="1", the frequency converter is in State 1: "Switching on inhibited".

Refer to *Illustration 4.1*.

Bit 01, OFF 2/ON 2

Coasting stop

When bit 01="0", a coasting stop and activation of the output relay 1 or 2 occurs if the output frequency is 0 Hz and if [Relay 123] has been selected in *5-40 Function Relay*.

When bit 01="1", the frequency converter is in State 1: "Switching on inhibited". Refer to *Illustration 4.1*.

Bit 02, OFF 3/ON 3

Quick stop using the ramp time of *3-81 Quick Stop Ramp Time*. When bit 02="0", a quick stop and activation of the output relay 1 or 2 occurs if the output frequency is 0 Hz and if [Relay 123] has been selected in *5-40 Function Relay*.

When bit 02="1", the frequency converter is in State 1: "Switching on inhibited".

Refer to *Illustration 4.1*.

Bit 03, Coasting/No coasting

Coasting stop Bit 03="0" leads to a stop. When bit 03="1", the frequency converter can start if the other start conditions are satisfied.

NOTICE

The selection in *8-50 Coasting Select* determines how bit 03 is linked with the corresponding function of the digital inputs.

Bit 04, Quick stop/Ramp

Quick stop using the ramp time of *3-81 Quick Stop Ramp Time*.

When bit 04="0", a quick stop occurs.

When bit 04="1", the frequency converter can start if the other start conditions are satisfied.

NOTICE

The selection in *8-51 Quick Stop Select* determines how bit 04 is linked with the corresponding function of the digital inputs.

Bit 05, Hold frequency output/Use ramp

When bit 05="0", the current output frequency is being maintained even if the reference value is modified.

When bit 05="1", the frequency converter can perform its regulating function again; operation occurs according to the respective reference value.

Bit 06, Ramp stop/Start

Normal ramp stop using the ramp times of the actual ramp as selected. In addition, activation of the output relay 01 or 04 if the output frequency is 0 Hz if Relay 123 has been selected in *5-40 Function Relay*. Bit 06="0" leads to a stop. When bit 06="1", the frequency converter can start if the other start conditions are satisfied.

NOTICE

The selection in *8-53 Start Select* determines how bit 06 is linked with the corresponding function of the digital inputs.

Bit 07, No function/Reset

Reset after switching off.

Acknowledges event in fault buffer.

When bit 07="0", no reset occurs.

When there is a slope change of bit 07 to "1", a reset occurs after switching off.

Bit 08, Jog 1 OFF/ON

Activation of the pre-programmed speed in *8-90 Bus Jog 1 Speed*. JOG 1 is only possible if bit 04="0" and bit 00-03="1".

Bit 09, Jog 2 OFF/ON

Activation of the pre-programmed speed in 8-91 *Bus Jog 2 Speed*. JOG 2 is only possible if bit 04="0" and bit 00-03="1".

Bit 10, Data invalid/valid

Is used to tell the frequency converter whether the control word is to be used or ignored. Bit 10="0" causes the control word to be ignored, giving the opportunity to turn off the control word when updating/reading parameters. Bit 10="1" causes the control word to be used. This function is relevant, because the control word is always contained in the telegram, regardless of which type of telegram is used.

Bit 11, No function/Slow down

Is used to reduce the speed reference value by the amount given in 3-12 *Catch up/slow Down Value* value. When bit 11="0", no modification of the reference value occurs. When bit 11="1", the reference value is reduced.

Bit 12, No function/Catch up

Is used to increase the speed reference value by the amount given in 3-12 *Catch up/slow Down Value*. When bit 12="0", no modification of the reference value occurs. When bit 12="1", the reference value is increased. If both slowing down and accelerating are activated (bit 11 and 12="1"), slowing down has priority, that is, the speed reference value is reduced.

Bits 13/14, Set-up selection

Bits 13 and 14 are used to choose between the four parameter set-ups according to *Table 4.5*.

The function is only possible if *Multi Set-up* has been chosen in 0-10 *Active Set-up*. The selection in 8-55 *Set-up Select* determines how bits 13 and 14 are linked with the corresponding function of the digital inputs. Changing set-up while running is only possible if the set-ups have been linked in 0-12 *This Set-up Linked to*.

Set-up	Bit 13	Bit 14
1	0	0
2	1	0
3	0	1
4	1	1

Table 4.5 Parameter Set-ups

Bit 15, No function/Reverse

Bit 15="0" causes no reversing.
Bit 15="1" causes reversing.

NOTICE

In the factory setting reversing is set to *digital* in 8-54 *Reversing Select*.

NOTICE

Bit 15 causes reversing only when *Ser. communication, Logic or or Logic and* is selected.

4.3.2 Status Word according to PROFIdrive Profile (STW)

The Status word is used to notify a master (for example, a PC) about the status of a slave.

Bit	Bit=0	Bit=1
00	Control not ready	Control ready
01	Drive not ready	Drive ready
02	Coasting	Enable
03	No error	Trip
04	OFF 2	ON 2
05	OFF 3	ON 3
06	Start possible	Start not possible
07	No warning	Warning
08	Speed ≠ reference	Speed=reference
09	Local operation	Bus control
10	Out of frequency limit	Frequency limit ok
11	No operation	In operation
12	Drive OK	Stopped, autostart
13	Voltage OK	Voltage exceeded
14	Torque OK	Torque exceeded
15	Timer OK	Timer exceeded

Table 4.6 Status Word Bits

Explanation of the status bits

Bit 00, Control not ready/ready

When bit 00="0", bit 00, 01 or 02 of the Control word is "0" (OFF 1, OFF 2 or OFF 3) - or the frequency converter is switched off (trip).

When bit 00="1", the frequency converter control is ready, but there is not necessarily power supply to the unit present (in the event of external 24 V supply of the control system).

Bit 01, VLT not ready/ready

Same significance as bit 00, however, there is a supply of the power unit. The frequency converter is ready when it receives the necessary start signals.

Bit 02, Coasting/Enable

When bit 02="0", bit 00, 01 or 02 of the Control word is "0" (OFF 1, OFF 2 or OFF 3 or coasting) - or the frequency converter is switched off (trip).

When bit 02="1", bit 00, 01 or 02 of the Control word is "1"; the frequency converter has not tripped.

Bit 03, No error/Trip

When bit 03="0", no error condition of the frequency converter exists.

When bit 03="1", the frequency converter has tripped and requires a reset signal before it can start.

Bit 04, ON 2/OFF 2

When bit 01 of the Control word is "0", then bit 04="0".
When bit 01 of the Control word is "1", then bit 04="1".

Bit 05, ON 3/OFF 3

When bit 02 of the Control word is "0", then bit 05="0".
When bit 02 of the Control word is "1", then bit 05="1".

Bit 06, Start possible/Start not possible

If PROFIdrive has been selected in *8-10 Control Word Profile*, bit 06 will be "1" after a switch-off acknowledgment, after activation of OFF2 or OFF3, and after switching on the mains voltage. Start not possible is reset, with bit 00 of the Control word being set to "0" and bit 01, 02 and 10 being set to "1".

Bit 07, No warning/Warning

Bit 07="0" means that there are no warnings.
Bit 07="1" means that a warning has occurred.

Bit 08, Speed≠reference/Speed=reference

When bit 08="0", the current speed of the motor deviates from the set speed reference value. This may occur, for example, when the speed is being changed during start/stop through ramp up/down.
When bit 08="1", the current speed of the motor corresponds to the set speed reference value.

Bit 09, Local operation/Bus control

Bit 09="0" indicates that the frequency converter has been stopped with the stop button on the LCP, or that [Linked to hand] or [Local] has been selected in *3-13 Reference Site*.
When bit 09="1", the frequency converter can be controlled through the serial interface.

Bit 10, Out of frequency limit/Frequency limit OK

When bit 10="0", the output frequency is outside the limits set in *4-52 Warning Speed Low* and *4-53 Warning Speed High*. When bit 10="1", the output frequency is within the indicated limits.

Bit 11, No operation/Operation

When bit 11="0", the motor does not turn.
When bit 11="1", the frequency converter has a start signal, or the output frequency is higher than 0 Hz.

Bit 12, Drive OK/Stopped, autostart

When bit 12="0", there is no temporary overloading of the inverter.

When bit 12="1", the inverter has stopped due to overloading. However, the frequency converter has not switched off (trip) and will start again after the overloading has ended.

Bit 13, Voltage OK/Voltage exceeded

When bit 13="0", the voltage limits of the frequency converter are not exceeded.
When bit 13="1", the direct voltage in the intermediate circuit of the frequency converter is too low or too high.

Bit 14, Torque OK/Torque exceeded

When bit 14="0", the motor torque is below the limit selected in *4-16 Torque Limit Motor Mode* and *4-17 Torque Limit Generator Mode*. When bit 14="1", the limit selected in *4-16 Torque Limit Motor Mode* or *4-17 Torque Limit Generator Mode* is exceeded.

Bit 15, Timer OK/Timer exceeded

When bit 15="0", the timers for the thermal motor protection and thermal frequency converter protection have not exceeded 100%.
When bit 15="1", one of the timers has exceeded 100%.

4.3.3 PROFIdrive State - Transition Diagram

In the PROFIdrive Control profile, the control bits 0 to 3 perform the basic start-up/power down functions, whereas the control bits 4-15 perform application-oriented control.

Illustration 4.1 shows the basic state-transition diagram, where control bits 0 to 3 control the transitions, and the corresponding status bit indicates the actual state. The black bullets indicate the priority of the control signals, where fewer bullets indicate lower priority, and more bullets indicate higher priority.

4

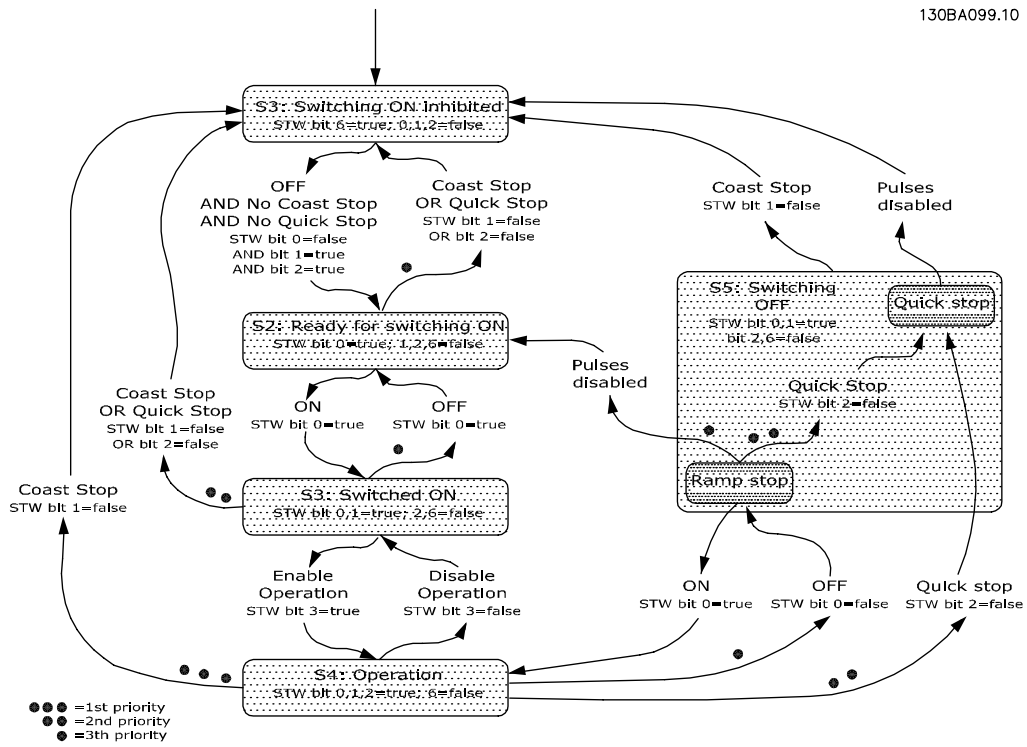
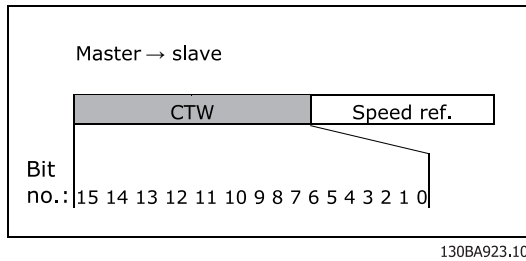

Illustration 4.1 PROFIdrive State Transition Diagram

4.4 Danfoss FC Control Profile



130BA923.10

Illustration 4.2 8-10 Control Word Profile=Frequency Converter profile

Bit	Bit value=0	Bit value=1
00	Reference value	External selection LSB
01	Reference value	External selection MSB
02	DC brake	Ramp
03	Coasting	No coasting
04	Quick stop	Ramp
05	Hold output frequency	Use ramp
06	Ramp stop	Start
07	No function	Reset
08	No function	Jog
09	Ramp 1	Ramp 2
10	Data invalid	Data valid
11	No function	Relay 01 active
12	No function	Relay 04 active
13	Parameter set-up	Selection LSB
14	Parameter set-up	Selection MSB
15	No function	Reverse

Table 4.7 Control Word Bits

Explanation of control bits

Bits 00/01

Bits 00 and 01 are used to choose between the four reference values, which are pre-programmed in 3-10 *Preset Reference* according to Table 4.8.

Programmed ref. value	Parameter	Bit 01	Bit 00
1	3-10 [0]	0	0
2	3-10 [1]	0	1
3	3-10 [2]	1	0
4	3-10 [3]	1	1

Table 4.8 Reference Values

NOTICE

In 8-56 *Preset Reference Select* select a selection is made to define how Bit 00/01 gates with the corresponding function on the digital inputs.

Bit 02, DC brake

Bit 02='0' leads to DC braking and stop. Braking current and duration are set in 2-01 *DC Brake Current* and 2-02 *DC Braking Time*. Bit 02='1' leads to ramping, 3-41 *Ramp 1 Ramp Up Time*

Bit 03, Coasting

Bit 03='0' causes the frequency converter to immediately release the motor (the output transistors are "shut off"), so that it coasts to a standstill.

Bit 03='1' enables the frequency converter to start the motor if the other starting conditions have been fulfilled.

NOTICE

In 8-50 *Coasting Select* a selection is made to define how Bit 03 gates with the corresponding function on a digital input.

Bit 04, Quick stop

Bit 04='0' causes a stop, in which the motor speed is ramped down to stop via 3-81 *Quick Stop Ramp Time*.

Bit 05, Hold output frequency

Bit 05='0' causes the present output frequency (in Hz) to freeze. The frozen output frequency can then be changed only with the digital inputs (5-10 *Terminal 18 Digital Input* to 5-15 *Terminal 33 Digital Input*) programmed to *Speed up* and *Speed down*.

NOTICE

If Freeze output is active, the frequency converter can only be stopped by the following:

- Bit 03 Coasting stop
- Bit 02 DC braking
- Digital input (5-10 *Terminal 18 Digital Input* to 5-15 *Terminal 33 Digital Input*) programmed to *DC braking*, *Coasting stop* or *Reset and coasting stop*

Bit 06, Ramp stop/start

Bit 06='0' causes a stop, in which the motor speed is ramped down to stop via the selected *ramp down* parameter.

Bit 06='1' permits the frequency converter to start the motor, if the other starting conditions have been fulfilled.

NOTICE

In 8-53 *Start Select Start* select a selection is made to define how Bit 06 Ramp stop/start gates with the corresponding function on a digital input.

Bit 07, Reset

Bit 07='0' no reset.

Bit 07='1' resets a trip. Reset is activated on the leading edge of the signal, that is, when changing from logic '0' to logic '1'.

Bit 08, Jog

Bit 08='1' causes the output frequency to be determined by 3-19 *Jog Speed [RPM]*.

Bit 09, Selection of ramp 1/2

Bit 09='0' means that ramp 1 is active (3-40 Ramp 1 Type to 3-47 Ramp 1 S-ramp Ratio at Decel. Start). Bit 09='1' means that ramp 2 (3-50 Ramp 2 Type to 3-57 Ramp 2 S-ramp Ratio at Decel. Start) is active.

Bit 10, Data not valid/Data valid

Is used to tell the frequency converter whether the control word is to be used or ignored. Bit 10="0" causes the control word to be ignored, giving the opportunity to turn off the control word when updating/reading parameters. Bit 10="1" causes the control word to be used. This function is relevant, because the control word is always contained in the telegram, regardless of which type of telegram is used.

Bit 11, Relay 01

Bit 11='0' Relay not activated. Bit 11 = '1' Relay 01 activated, provided Control word bit 11 has been chosen in 5-40 Function Relay.

Bit 12, Relay 02

Bit 12='0' Relay 02 has not been activated. Bit 12='1' Relay 02 has been activated, provided Control word bit 12 has been chosen in 5-40 Function Relay.

Bit 13/14, Selection of set-up

Bits 13 and 14 are used to select one of 4 menu set-ups according to Table 4.9:

Set-up	Bit 14	Bit 13
1	0	0
2	0	1
3	1	0
4	1	1

Table 4.9 Menu Set-ups

The function is only possible when Multi-Set-ups is selected in 0-10 Active Set-up.

NOTICE

In 8-55 Set-up Select a selection is made to define how Bit 13/14 gates with the corresponding function on the digital inputs.

Bit 15 Reverse

Bit 15='0' causes no reversing. Bit 15='1' causes reversing.

NOTICE

In the factory setting reversing is set to digital in 8-54 Reversing Select. Bit 15 causes reversing only when Ser. communication, Logic AND or Logic OR is selected.

4.4.1 Status Word according to Frequency Converter Profile (STW)

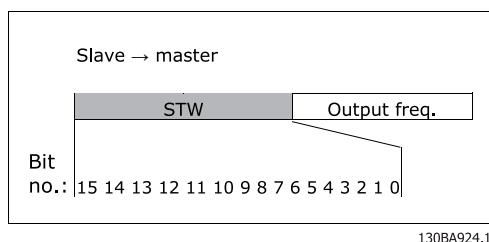

Illustration 4.3 8-10 Control Word Profile

Bit	Bit value=0	Bit value=1
00	Control not ready	Control ready
01	Drive not ready	Drive ready
02	Coasting	Enable
03	No error	Trip
04	No error	Error (no trip)
05	Reserved	-
06	No error	Trip lock
07	No warning	Warning
08	Speed ≠ reference	Speed = reference
09	Local operation	Bus control
10	Out of frequency limit	Frequency limit ok
11	No operation	In operation
12	Drive ok	Stopped, auto start
13	Voltage ok	Voltage exceeded
14	Torque ok	Torque exceeded
15	Thermal ok	Thermal exceeded

Table 4.10 Staus Word Bits

Explanation of the status bits

Bit 00, Control ready

Bit 00='0' means that the frequency converter has tripped. Bit 00='1' means that the frequency converter controls are ready, but that the power component is not necessarily receiving any power supply (in the event of external 24 V supply to controls).

Bit 01, Drive ready

Bit 01='1'. The frequency converter is ready for operation.

Bit 02, Coasting stop

Bit 02='0'. The frequency converter has released the motor. Bit 02='1'. The frequency converter can start the motor when a start command is given.

Bit 03, No error/Trip

Bit 03='0' means that the frequency converter is not in fault mode. Bit 03='1' means that the frequency converter is tripped, and that a reset signal is required to re-establish operation.

Bit 04, No error/Error (no trip)

Bit 04='0' means that the frequency converter is not in fault mode.

Bit 04='1' means that there is a frequency converter error but no trip.

Bit 05, Reserved

Bit 05 is not used in the status word.

Bit 06, No error/Trip lock

Bit 06='0' means that the frequency converter is not in fault mode.

Bit 06 = '1' means that the frequency converter is tripped, and locked.

Bit 07, No warning/Warning

Bit 07='0' means that there are no warnings.

Bit 07='1' means that a warning has occurred.

Bit 08, Speed≠ reference/Speed=reference

Bit 08='0' means that the motor is running, but that the present speed is different from the preset speed reference. For example, this might occur while the speed is being ramped up/down during start/stop.

Bit 08='1' means that the present motor speed matches the preset speed reference.

Bit 09, Local operation/Bus control

Bit 09='0' means that [Stop/Reset] is activated on the control unit, or that Local control in 3-13 Reference Site is selected. It is not possible to control the frequency converter via serial communication.

Bit 09='1' means that it is possible to control the frequency converter via the fieldbus/serial communication.

Bit 10, Out of frequency limit

Bit 10='0', if the output frequency has reached the value in 4-11 Motor Speed Low Limit [RPM] or 4-13 Motor Speed High Limit [RPM].

Bit 10='1' means that the output frequency is within the defined limits.

Bit 11, No operation/In operation

Bit 11='0' means that the motor is not running.

Bit 11='1' means that the frequency converter has a start signal or that the output frequency is greater than 0 Hz.

Bit 12, Drive OK/Stopped, auto start

Bit 12='0' means that there is no temporary over temperature on the inverter.

Bit 12='1' means that the inverter has stopped because of over temperature, but that the unit has not tripped and resumes operation once the over temperature stops.

Bit 13, Voltage OK/Voltage exceeded

Bit 13='0' means that there are no voltage warnings.

Bit 13='1' means that the DC voltage in the frequency converter's intermediate circuit is too low or too high.

Bit 14, Torque OK/Torque limit exceeded

Bit 14='0' means that the motor current is lower than the torque limit selected in 4-16 Torque Limit Motor Mode and 4-17 Torque Limit Generator Mode Torque limit.

Bit 14='1' means that the torque limit in 4-16 Torque Limit Motor Mode and 4-17 Torque Limit Generator Mode Torque limit has been exceeded. The nominal torque can be read in 16-16 Torque [Nm].

Bit 15, Thermal OK/limit exceeded

Bit 15='0' means that the timers for both motor thermal protection and frequency converter thermal protection, have not exceeded 100%.

Bit 15='1' means that one of the limits has exceeded 100%.

4.5 Reference Handling

4.5.1 Bus Speed Reference Value

0%=0 hex

100%=4000 hex

-100%=C000 hex

Depending of the setting of 3-00 Reference Range, the reference is scaled from - Max. to + Max. or from Min. to Max.

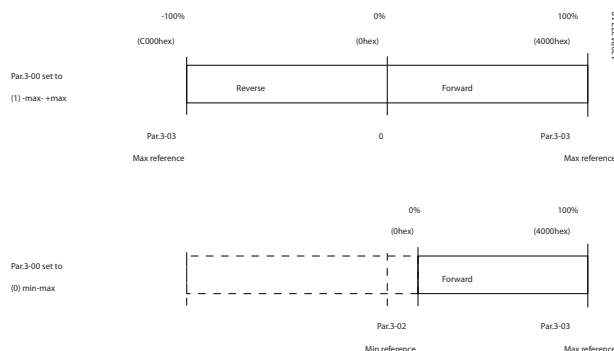

Illustration 4.4 Scaling of Reference Values

The actual reference [Ref. %] in the frequency converter depends on the settings in the following parameters:

- 1-23 Motor Frequency
- 1-25 Motor Nominal Speed
- 3-02 Minimum Reference
- 3-03 Maximum Reference

All references provided to the frequency converter are added to the total reference value. If a reference is to be controlled by the fieldbus only, ensure that all other reference inputs are zero.

This means that digital and analogue input terminals should not be used for reference signals. The default setting (0%) should be maintained for preset references in 3-10 Preset Reference.

CAUTION

If the bus speed reference is negative, and the control word contains a run reverse signal, the frequency converter will run clockwise (- to - is +).

MAV is scaled in the same way as the reference.

5 Parameters

5.1 Parameter Group 8-**

8-01 Control Site		
Option:	Function:	
		The setting in this parameter overrides the settings in <i>8-50 Coasting Select</i> to <i>8-56 Preset Reference Select</i> .
[0]	Digital and ctrl.word	Control by using both digital input and control word.
[1]	Digital only	Control by using digital inputs only.
[2]	Controlword only	Control by using control word only.

8-02 Control Word Source		
Option:	Function:	
		<p>NOTICE This parameter cannot be adjusted while the motor is running.</p> <p>Select the source of the control word: one of two serial interfaces or four installed options. During initial power-up, the frequency converter automatically sets this parameter to [3] <i>Option A</i> if it detects a valid fieldbus option installed in slot A. If the option is removed, the frequency converter detects a change in the configuration, sets <i>8-02 Control Word Source</i> back to default setting RS-485, and the frequency converter trips. If an option is installed after initial power-up, the setting of <i>8-02 Control Word Source</i> does not change, but the frequency converter trips and displays: <i>Alarm 67 Option Changed</i>.</p> <p>When retrofitting a bus option into a frequency converter, that did not have a bus option installed to begin with, take an ACTIVE decision to move the control to Bus based. This is done for safety reasons to avoid an accidental change.</p>
[0]	None	
[1]	FC RS485	
[2]	FC USB	
[3]	Option A	
[4]	Option B	
[5]	Option C0	
[6]	Option C1	
[30]	External Can	

8-03 Control Word Timeout Time		
Range:	Function:	
1 s*	[0.1 - 18000 s]	Enter the maximum time expected to pass between the reception of two consecutive telegrams. If this time is exceeded, it indicates that the serial communication has stopped. The function selected in <i>8-04 Control Word Timeout Function</i> is then carried out. A valid control word triggers the time-out counter.

8-04 Control Word Timeout Function		
Select the time-out function. The time-out function activates when the control word fails to be updated within the time period specified in <i>8-03 Control Word Timeout Time</i> .		
Option:	Function:	
[0]	Off	Resumes control via serial bus (fieldbus or standard) using the most recent control word.
[1]	Freeze output	Freezes output frequency until communication resumes.
[2]	Stop	Stops with auto restart when communication resumes.
[3]	Jogging	Runs the motor at JOG frequency until communication resumes.
[4]	Max. speed	Runs the motor at maximum frequency until communication resumes.
[5]	Stop and trip	Stops the motor, then resets the frequency converter to restart: via the fieldbus, via [Reset], or via a digital input.
[7]	Select setup 1	Changes the set-up upon reestablishment of communication following a control word time-out. If communication resumes after a time-out, <i>8-05 End-of-Timeout Function</i> defines whether to resume the set-up used before the time-out, or to retain the set-up endorsed by the time-out function.
[8]	Select setup 2	See [7] <i>Select setup 1</i>
[9]	Select setup 3	See [7] <i>Select setup 1</i>
[10]	Select setup 4	See [7] <i>Select setup 1</i>
[26]	Trip	

NOTICE

To change the set-up after a time-out, the following configuration is required:
Set 0-10 Active Set-up to [9] Multi set-up and select the relevant link in 0-12 This Set-up Linked to.

8-05 End-of-Timeout Function		
Option:	Function:	
		Select the action after receiving a valid control word following a time-out. This parameter is active only when 8-04 Control Timeout Function is set to [7] Set-up 1, [8] Set-up 2, [9]Set-up 3 or [10] Set-up 4.
[0]	Hold set-up	Retains the set-up selected in 8-04 Control Timeout Function and displays a warning, until 8-06 Reset Control Timeout toggles. Then the frequency converter resumes its original set-up.
[1]	Resume set-up	Resumes the set-up active before the time-out.

8-06 Reset Control Word Timeout		
This parameter is active only when [0] Hold set-up has been selected in 8-05 End-of-Timeout Function.		
Option:	Function:	
[0]	Do not reset	Retains the set-up specified in 8-04 Control Word Timeout Function, following a control word time-out.
[1]	Do reset	Returns the frequency converter to the original set-up following a control word time-out. The frequency converter performs the reset and then immediately reverts to the [0] Do not reset setting

8-10 Control Word Profile		
Select the interpretation of the control and status words corresponding to the installed fieldbus. Only the selections valid for the fieldbus installed in slot A will be visible in the display. For guidelines in selection of [0] FC profile and [1] PROFIdrive profile refer to the Serial communication via RS-485 Interface section.		
For additional guidelines in the selection of [1] PROFIdrive profile, [5] ODVA and [7] CANopen DSP 402, refer to the Operating Instructions for the installed fieldbus.		
Option:	Function:	
[0]	FC profile	
[1]	PROFIdrive profile	
[5]	ODVA	
[7]	CANopen DSP 402	
[8]	MCO	

8-13 Configurable Status Word STW		
Option:	Function:	
		This parameter enables configuration of bits 12–15 in the status word.
[0]	No function	
[1] *	Profile Default	Function corresponds to the profile default selected in 8-10 Control Profile.
[2]	Alarm 68 Only	Only set in case of an Alarm 68.
[3]	Trip excl. Alarm 68	Set in case of a trip, except if Alarm 68 executes the trip.

8-13 Configurable Status Word STW		
Option:	Function:	
[10]	T18 DI status.	The bit indicates the status of terminal 18. "0" indicates that the terminal is low "1" indicates that the terminal is high
[11]	T19 DI status.	The bit indicates the status of terminal 19. "0" indicates that the terminal is low "1" indicates that the terminal is high
[12]	T27 DI status.	The bit indicates the status of terminal 27. "0" indicates that the terminal is low "1" indicates that the terminal is high
[13]	T29 DI status.	The bit indicates the status of terminal 29. "0" indicates that the terminal is low "1" indicates that the terminal is high
[14]	T32 DI status.	The bit indicates the status of terminal 32. "0" indicates that the terminal is low "1" indicates that the terminal is high
[15]	T33 DI status.	The bit indicates the status of terminal 33. "0" indicates that the terminal is low "1" indicates that the terminal is high
[16]	T37 DI status	The bit indicates the status of terminal 37. "0" indicates T37 is low (safe stop) "1" indicates T37 is high (normal)
[21]	Thermal warning	The thermal warning turns on when the temperature exceeds the limit in the motor, the frequency converter, the brake resistor, or the thermistor.
[30]	Brake fault (IGBT)	Output is Logic '1' when the brake IGBT is short-circuited. Use this function to protect the frequency converter if there is a fault on the brake modules. Use the output/relay to cut out the main voltage from the frequency converter.
[40]	Out of ref. range	
[60]	Comparator 0	See parameter group 13-1* Comparators. If Comparator 0 is evaluated as TRUE, the output goes high. Otherwise, it is low.
[61]	Comparator 1	See parameter group 13-1* Comparators. If Comparator 1 is evaluated as TRUE, the output goes high. Otherwise, it is low.
[62]	Comparator 2	See parameter group 13-1* Comparators. If Comparator 2 is evaluated as TRUE, the output goes high. Otherwise, it is low.
[63]	Comparator 3	See parameter group 13-1* Comparators. If Comparator 3 is evaluated as TRUE, the output goes high. Otherwise, it is low.
[64]	Comparator 4	See parameter group 13-1* Comparators. If Comparator 4 is evaluated as TRUE, the output goes high. Otherwise, it is low.
[65]	Comparator 5	See parameter group 13-1* Comparators. If Comparator 5 is evaluated as TRUE, the output goes high. Otherwise, it is low.
[70]	Logic Rule 0	See parameter group 13-4* Logic Rules. If Logic Rule 0 is evaluated as TRUE, the output goes high. Otherwise, it is low.

8-13 Configurable Status Word STW		
Option:	Function:	
[71]	Logic Rule 1	See parameter group 13-4* <i>Logic Rules</i> . If Logic Rule 1 is evaluated as TRUE, the output goes high. Otherwise, it is low.
[72]	Logic Rule 2	See parameter group 13-4* <i>Logic Rules</i> . If Logic Rule 2 is evaluated as TRUE, the output goes high. Otherwise, it is low.
[73]	Logic Rule 3	See parameter group 13-4* <i>Logic Rules</i> . If Logic Rule 3 is evaluated as TRUE, the output goes high. Otherwise, it is low.
[74]	Logic Rule 4	See parameter group 13-4* <i>Logic Rules</i> . If Logic Rule 4 is evaluated as TRUE, the output goes high. Otherwise, it is low.
[75]	Logic Rule 5	See parameter group 13-4* <i>Logic Rules</i> . If Logic Rule 5 is evaluated as TRUE, the output goes high. Otherwise, it is low.
[80]	SL Digital Output A	See 13-52 <i>SL Controller Action</i> . The output goes high whenever the Smart Logic Action [38] <i>Set digital out A high</i> is executed. The output goes low whenever the Smart Logic Action [32] <i>Set digital out A low</i> is executed.
[81]	SL Digital Output B	See 13-52 <i>SL Controller Action</i> . The input goes high whenever the Smart Logic Action [39] <i>Set digital out B high</i> is executed. The input goes low whenever the Smart Logic Action [33] <i>Set digital out B low</i> is executed.
[82]	SL Digital Output C	See 13-52 <i>SL Controller Action</i> . The input goes high whenever the Smart Logic Action [40] <i>Set digital out C high</i> is executed. The input goes low whenever the Smart Logic Action [34] <i>Set digital out C low</i> is executed.
[83]	SL Digital Output D	See 13-52 <i>SL Controller Action</i> . The input goes high whenever the Smart Logic Action [41] <i>Set digital out D high</i> is executed. The input goes low whenever the Smart Logic Action [35] <i>Set digital out D low</i> is executed.
[84]	SL Digital Output E	See 13-52 <i>SL Controller Action</i> . The input goes high whenever the Smart Logic Action [42] <i>Set digital out E high</i> is executed. The input goes low whenever the Smart Logic Action [36] <i>Set digital out E low</i> is executed.
[85]	SL Digital Output F	See 13-52 <i>SL Controller Action</i> . The input goes high whenever the Smart Logic Action [43] <i>Set digital out F high</i> is executed. The input goes low whenever the Smart Logic Action [37] <i>Set digital out F low</i> is executed.

8-14 Configurable Control Word CTW		
Option:	Function:	
		Selection of control word bit 10, if it is active low or active high.
[0]	None	
[1]	Profile default	
[2]	CTW Valid, active low	
[3]	Safe Option Reset	
[4]	PID error inverse	When enabled, it inverts the resulting error from the process PID controller. Available only if "Configuration Mode" is set to "Surface Winder", "Extended PID Speed OL" or "Extended PID Speed CL".
[5]	PID reset I part	When enabled, resets the I-part of the Process PID controller. Equivalent to 7-40 <i>Process PID I-part Reset</i> . Available only if "Configuration Mode" is set to "Surface Winder", "Extended PID Speed OL" or "Extended PID Speed CL".
[6]	PID enable	When enabled, enables the extended process PID controller. Equivalent to 7-50 <i>Process PID Extended PID</i> . Available only if "Configuration Mode" is set "Extended PID Speed OL" or "Extended PID Speed CL".

8-50 Coasting Select		
Option:	Function:	
		Select control of the coasting function via the terminals (digital input) and/or via the bus.
[0]	Digital input	Activates Start command via a digital input.
[1]	Bus	Activates Start command via the serial communication port or fieldbus option.
[2]	Logic AND	Activates Start command via the fieldbus/serial communication port, AND additionally via one of the digital inputs.
[3]	Logic OR	Activates Start command via the fieldbus/serial communication port OR via one of the digital inputs.

8-51 Quick Stop Select		
Select control of the Quick Stop function via the terminals (digital input) and/or via the bus.		
Option:	Function:	
[0]	Digital input	
[1]	Bus	
[2]	Logic AND	
[3]	Logic OR	

8-52 DC Brake Select		
Option:	Function:	
		Select control of the DC brake via the terminals (digital input) and/or via the fieldbus. NOTICE Only selection [0] Digital input is available when 1-10 Motor Construction is set to [1] PM non-salient SPM.
[0]	Digital input	Activates Start command via a digital input.
[1]	Bus	Activates Start command via the serial communication port or fieldbus option.
[2]	Logic AND	Activates Start command via the fieldbus/serial communication port, AND additionally via one of the digital inputs.
[3]	Logic OR	Activates Start command via the fieldbus/serial communication port OR via one of the digital inputs.

8-53 Start Select		
Option:	Function:	
		Select control of the frequency converter start function via the terminals (digital input) and/or via the fieldbus.
[0]	Digital input	Activates Start command via a digital input.
[1]	Bus	Activates Start command via the serial communication port or fieldbus option.
[2]	Logic AND	Activates Start command via the fieldbus/serial communication port, AND additionally via one of the digital inputs.
[3]	Logic OR	Activates Start command via the fieldbus/serial communication port OR via one of the digital inputs.

8-54 Reversing Select		
Option:	Function:	
[0]	Digital input	Select control of the frequency converter reverse function via the terminals (digital input) and/or via the fieldbus.
[1]	Bus	Activates the Reverse command via the serial communication port or fieldbus option.
[2]	Logic AND	Activates the Reverse command via the fieldbus/serial communication port, AND additionally via one of the digital inputs.
[3]	Logic OR	Activates the Reverse command via the fieldbus/serial communication port OR via one of the digital inputs.

8-55 Set-up Select		
Option:	Function:	
		Select control of the frequency converter set-up selection via the terminals (digital input) and/or via the fieldbus.
[0]	Digital input	Activates the set-up selection via a digital input.
[1]	Bus	Activates the set-up selection via the serial communication port or fieldbus option.
[2]	Logic AND	Activates the set-up selection via the fieldbus/serial communication port, AND additionally via one of the digital inputs.
[3]	Logic OR	Activate the set-up selection via the fieldbus/serial communication port OR via one of the digital inputs.

8-56 Preset Reference Select		
Option:	Function:	
		Select control of the frequency converter Preset Reference selection via the terminals (digital input) and/or via the fieldbus.
[0]	Digital input	Activates Preset Reference selection via a digital input.
[1]	Bus	Activates Preset Reference selection via the serial communication port or fieldbus option.
[2]	Logic AND	Activates Preset Reference selection via the fieldbus/serial communication port, AND additionally via one of the digital inputs.
[3]	Logic OR	Activates the Preset Reference selection via the fieldbus/serial communication port OR via one of the digital inputs.

5.2 Parameter Group 12-**

5.2.1 12-0* IP Settings

12-00 IP Address Assignment		
Option:	Function:	
		Selects the IP Address assignment method.
[0] *	Manual	IP-address can be set in 12-01 IP Address IP Address.
[1]	DHCP	IP-address is assigned via DHCP server.
[2]	BOOTP	IP-address is assigned via BOOTP server.

12-01 IP Address		
Range:	Function:	
[000.000.000.000 - 255.255.255.255]	Configure the IP address of the option. Read-only if 12-00 IP Address Assignment set to DHCP or BOOTP.	

12-02 Subnet Mask

Range:	Function:
[000.000.000.000 - 255.255.255.255]	Configure the IP subnet mask of the option. Read-only if <i>12-00 IP Address Assignment</i> set to DHCP or BOOTP.

12-03 Default Gateway

Range:	Function:
[000.000.000.000 - 255.255.255.255]	Configure the IP default gateway of the option. Read-only if <i>12-00 IP Address Assignment</i> set to DHCP or BOOTP.

12-04 DHCP Server

Range:	Function:
[000.000.000.000 - 255.255.255.255]	Read only. Displays the IP address of the found DHCP or BOOTP server.

NOTICE

A power-cycle is necessary after setting the IP parameters manually.

12-05 Lease Expires

Range:	Function:
Size related* [0 - 0]	Read only. Displays the lease-time left for the current DHCP-assigned IP address.

12-06 Name Servers

Range:	Function:
0 * [0 - 2147483647]	IP addresses of Domain Name Servers. Can be automatically assigned when using DHCP.

12-07 Domain Name

Range:	Function:
0 [0 - 2147483647]	Domain name of the attached network. Can be automatically assigned when using DHCP network.

12-08 Host Name

Range:	Function:
Blank [0-19 characters]	Logical (given) name of option.

12-09 Physical Address

Range:	Function:
0 * [0 - 0]	Read only. Displays the Physical (MAC) address of the option.

5.2.2 12-1* Ethernet Link Parameters

Applies for whole parameter group.

Index [0] is used for Port 1 and Index [1] is used for Port 2. For EtherCAT, Index [0] is for In Port and Index [1] is for Out port.

12-10 Link Status		
Option:	Function:	
		Read only. Displays the link status of the Ethernet ports.
[0]	No Link	
[1]	Link	

12-11 Link Duration		
Range:	Function:	
Size related* [0 - 0]	Read only. Displays the duration of the present link on each port in dd:hh:mm:ss.	

12-12 Auto Negotiation

Option:	Function:	
		Configures Auto Negotiation of Ethernet link parameters, for each port: ON or OFF.
[0]	Off	<i>Link Speed</i> and <i>Link Duplex</i> can be configured in <i>12-13 Link Speed</i> and <i>12-14 Link Duplex</i> .
[1]	On	

12-13 Link Speed

Option:	Function:	
		Forces the link speed for each port in 10 or 100 Mbps. If <i>12-12 Auto Negotiation</i> is set to: [ON], this parameter is read only and displays the actual link speed. "None" is displayed if no link is present.
[0] *	None	
[1]	10 Mbps	
[2]	100 Mbps	

12-14 Link Duplex

Option:	Function:	
		Forces the duplex for each port to Full or Half duplex. If <i>12-12 Auto Negotiation</i> is set to: [ON], this parameter is read only.
[0]	Half Duplex	
[1]	Full Duplex	

NOTICE

In POWERLINK this parameter is locked to half duplex.

5.2.3 12-2* Process Data

12-21 Process Data Config Write

Range: **Function:**

[[0 - 9] PCD read 0 - 9]	Configuration of readable process data.
--------------------------	---

In POWERLINK this parameter is read only. Same applies for 12-22 Process Data Config Read, 12-23 Process Data Config Write Size and 12-24 Process Data Config Read Size.

12-22 Process Data Config Read

Range: **Function:**

[[0 - 9] PCD read 0 - 9]	Configuration of readable process data.
--------------------------	---

12-27 Primary Master

Option: **Function:**

	<p>This parameter control allows fast swapping of masters. If this parameter is set 0.0.0.0, the first masters that access the frequency converter locks the interface for other masters.</p> <p>If the communication is lost, the frequency converter will hold the connection for 30 s before a second master can take control.</p> <p>By setting [0] IP address of first Master and setting [1] IP address of second Master, only these two masters can control the frequency converter and the second master does not have to wait 30 s to take control.</p> <p>Only one master may control the frequency converter at any time, otherwise the frequency converter might malfunction.</p>
[0] *	IP address of first Master.
[1]	IP address of second Master.

12-28 Store Data Values

Option: **Function:**

	<p>This parameter activates a function that stores all parameter values in the non-volatile memory (EEPROM) thus retaining parameter values at power-down.</p> <p>The parameter returns to "Off".</p>
[0] *	Off The store function is inactive.
[1]	Store All set-ups All parameter values are stored in the non-volatile memory, in all 5 set-ups.

12-29 Store Always

Option: **Function:**

	Activates function that always stores received parameter data in non-volatile memory (EEPROM).
[0] *	Off
[1]	On

5.2.4 Modbus TCP

12-40 Status Parameter

Range: **Function:**

	Read only. Displays the Modbus TCP- specific 16-bit Status word.
0 *	[0 - 0]

Bit	Description	Bit=[0]	Bit=[1]
0	Link Status port 1	Disconnected	Connected
1	Link Status port 2	Disconnected	Connected
2	Link speed	0/10 Mbps	100 Mbps
3	Link Duplex	Half	Full
4	Port 502 communication	No	Yes
5	UNUSED	-	-
6	Valid IP address	No	Yes
7	Modbus timeout (30 s)	No	Yes
8	Duplicate IP	No	Yes
9	Register 7 error	No	Yes
10	FTP server	Disabled	Enabled
11	HTTP server	Disabled	Enabled
12	SMTP service	Disabled	Enabled
13	Cable diagnosis	Disabled	Enabled
14	Auto crossover	Disabled	Enabled
15	IGMP snooping	Disabled	Enabled

Table 5.1 Bit Descriptions

12-41 Slave Message Count

Range: **Function:**

	Read only. Displays the number of Modbus messages received and processed by the slave.
0 *	[0 - 0]

12-42 Slave Exception Message Count

Range: **Function:**

	Read only. Displays the number of Modbus messages for which the slave has sent an exception response.
0 *	[0 - 0]

5.2.5 12-8* Other Ethernet Services

12-80 FTP Server		
Option:	Function:	
[0]	Disabled	Disables the built-in FTP server.
[1]	Enabled	Enables the built-in FTP server.

12-81 HTTP Server		
Option:	Function:	
[0]	Disabled	
[1]	Enabled	Enables the built-in HTTP (web) server.

12-82 SMTP Service		
Option:	Function:	
[0]	Disabled	
[1]	Enabled	Enables the SMTP (e-mail) service on the option.

12-89 Transient Socket Channel Port		
Range:	Function:	
0*	[0-9999]	Configures the TCP port-number for the transient socket channel. This enables Frequency converter-telegrams to be sent transiently on Ethernet via TCP. Default value is 4000, 0 means disabled.

5.2.6 12-9* Advanced Ethernet Settings

12-90 Cable Diagnostic		
Option:	Function:	
		Enables/disables advanced Cable diagnosis function. If enabled, the distance to cable errors can be read out in <i>12-93 Cable Error Length</i> . The parameter resumes to the default setting of Disable after the diagnostics have finished.
[0]	Disabled	
[1]	Enabled	

NOTICE

The cable diagnostics function is only issued on ports where there is no link (see *12-10 Link Status, Link Status*)

12-91 Auto Cross-Over		
Option:	Function:	
[0]	Disable	Disables the auto cross-over function.
[1] *	Enable	Enables the auto cross-over function.

NOTICE

Disabling of the auto cross-over function requires crossed Ethernet cables for daisy-chaining the options.

12-92 IGMP Snooping		
Option:	Function:	
		This prevents flooding of the Ethernet protocol stack by only forwarding multicast packets to ports that are a member of the multicast group.
[0]	Disable	Disables the IGMP snooping function.
[1] *	Enable	Enables the IGMP snooping function.

12-93 Cable Error Length		
Range:	Function:	
0 *	[0 - 65535]	If Cable Diagnostics is enabled in <i>12-90 Cable Diagnostic</i> , the built-in switch is possible via Time Domain Reflectometry (TDR). This measurement technique detects common cabling problems such as open circuits, short circuits, and impedance mismatches or breaks in transmission cables. The distance from the option to the error is displayed in meters with an accuracy of ± 2 m. The value 0 means that no errors detected.

12-94 Broadcast Storm Protection		
Range:	Function:	
-1 %*	[-1 - 20 %]	The built-in switch is capable of protecting the switch system from receiving too many broadcast packages, which can use up network resources. The value indicates a percentage of the total bandwidth that is allowed for broadcast messages. Example: The "OFF" means that the filter is disabled - all broadcast messages passes through. The value "0%" means that no broadcast messages passes through. A value of "10%" means that 10% of the total bandwidth is allowed for broadcast messages, if the amount of broadcast messages increases above the 10% threshold, they will be blocked.
-1 %*	[-1 - 20 %]	

12-95 Broadcast Storm Filter		
Option:	Function:	
		Applies to <i>12-94 Broadcast Storm Protection</i> ; if the Broadcast Storm Protection should also include Multicast telegrams.
[0]	Broadcast only	
[1]	Broadcast & Multicast	

12-98 Interface Counters		
Range:	Function:	
4000 *	[0 - 4294967295]	Read only. Advanced Interface counters, from built-in switch, can be used for low-level troubleshooting, The parameter shows a sum of port 1+port 2.

12-99 Media Counters		
Range:	Function:	
0 *	[0 - 4294967295]	Read only. Advanced Interface counters, from built-in switch, can be used for low-level troubleshooting, The parameter shows a sum of port 1+port 2.

5.3 Parameter List

5

Parameter	Default value	4-set-up	Change during operation	Conversion index	Type
8-0* General Settings					
8-01 Control Site	[0] Digital and ctrl.word	All set-ups	TRUE	-	Uint8
8-02 Control Word Source	null	All set-ups	TRUE	-	Uint8
8-03 Control Word Timeout Time	1.0 s	1 set-up	TRUE	-1	Uint32
8-04 Control Word Timeout Function	null	1 set-up	TRUE	-	Uint8
8-05 End-of-Timeout Function	[1] Resume set-up	1 set-up	TRUE	-	Uint8
8-06 Reset Control Word Timeout	[0] Do not reset	All set-ups	TRUE	-	Uint8
8-1* Ctrl. Word Settings					
8-10 Control Word Profile	[0] FC profile	All set-ups	TRUE	-	Uint8
8-13 Configurable Status Word STW	[1] Profile default	All set-ups	TRUE	-	Uint8
8-14 Configurable Control Word CTW	[1] Profile default	All set-ups	TRUE	-	Uint8
8-5* Digital/Bus					
8-50 Coasting Select	[3] Logic OR	All set-ups	TRUE	-	Uint8
8-51 Quick Stop Select	[3] Logic OR	All set-ups	TRUE	-	Uint8
8-52 DC Brake Select	[3] Logic OR	All set-ups	TRUE	-	Uint8
8-53 Start Select	[3] Logic OR	All set-ups	TRUE	-	Uint8
8-54 Reversing Select	[3] Logic OR	All set-ups	TRUE	-	Uint8
8-55 Set-up Select	[3] Logic OR	All set-ups	TRUE	-	Uint8
8-56 Preset Reference Select	[3] Logic OR	All set-ups	TRUE	-	Uint8

Table 5.2 Parameter Group 8-**

Parameter	Default Value	Range	Conversion Index	Data Type	Array
12-0* IP Settings					
12-00 IP Address Assignment	0.0.0.0	0-255	-	Unsigned 8	-
12-01 IP Address	0.0.0.0	0-255	-	Oct. string 4	-
12-02 Subnet Mask	0.0.0.0	0-255	-	Oct. string 4	-
12-03 Default Gateway	0.0.0.0	0-255	-	Oct. string 4	-
12-04 DHCP Server	0.0.0.0	0-255	-	Oct. string 4	-
12-05 Lease Expires	00:00:00:00	-	-	Time diff. w/date	-
12-06 Name Servers	0.0.0.0	0-255	-	Oct. string 4	-
12-07 Domain Name	-	max. 19 ch.	-	Visible string 48	-
12-08 Host Name	-	max. 19 ch.	-	Visible string 48	-
12-09 Physical Address	00:1B:08:00:00:00	-	-	Visible string 17	-
12-1* Ethernet Link Parameters					
12-10 Link Status	[0] No Link	[0 - 1]	-	Unsigned 8	[0-1]
12-11 Link Duration	00:00:00:00	-	-	Time diff. w/date	[0-1]
12-12 Auto Negotiation	[1] On	[0-1]	-	Unsigned 8	[0-1]
12-13 Link Speed	[0] None	[0-2]	-	Unsigned 8	[0-1]
12-14 Link Duplex	[1] Full Duplex	[0-1]	-	Unsigned 8	[0-1]
12-2* Process Data					
12-21 Process Data Config Write	-	-	-	Unsigned 16	[0-9]
12-22 Process Data Config Read	-	-	-	Unsigned 16	[0-9]
12-27 Master Address	0.0.0.0.	0-255	-		Oct. string [4]
12-28 Store Data Values	[0] Off	[0-1]	-	Unsigned 8	-
12-29 Store Always	[0] Off	[0-1]	-	Unsigned 8	-
12-4* Modbus TCP					
12-40 Status Parameter		[0-1]			
12-41 Slave Message Count	0				
12-42 Slave Exception Message Count	0				
12-8* Other Ethernet Services					
12-80 FTP Server	[0] Disable	[0-1]	-	Unsigned 8	-
12-81 HTTP Server	[0] Disable	[0-1]	-	Unsigned 8	-
12-82 SMTP Service	[0] Disable	[0-1]	-	Unsigned 8	-
12-89 Transparent Socket Channel Port	[0] Disable	[0-1]	-	Unsigned 8	-
12-9* Advanced Ethernet Settings					
12-90 Cable Diagnostic	[0] Disable	[0-1]	-	Unsigned 8	-
12-91 Auto Cross Over	[0] Enable	[0-1]	-	Unsigned 8	-
12-92 IGMP Snooping	[0] Enable	[0-1]	-	Unsigned 8	-
12-93 Cable Error Length	0	0-200	0	Unsigned 16	[0-1]
12-94 Broadcast Storm Protection	0	Off-20%	-	Unsigned 16	[0-1]
12-95 Broadcast Storm Filter	[1] Enable	[0-1]	-	Unsigned 8	[0-1]
12-98 Interface Counters	0	0-65535	-	Unsigned 16	[0-10]
12-99 Media Counters	0	0 - 65535	-	Unsigned 16	[0-11]

Table 5.3 Parameter Group 12-**

5.4 Data Types

5.4.1 Data Types Supported by FC 102/FC 202/FC 302

The number to the left refers to a conversion figure, the one on the right to be used when writing or reading parameters.

Conversion index	Conversion factor
67	1/60
6	1000000
5	100000
4	10000
3	1000
2	100
1	10
0	1
-1	0.1
-2	0.01
-3	0.001
-4	0.0001
-5	0.00001
-6	0.000001









Table 5.4 Conversion Index

6 Troubleshooting

6.1 Step-by-step Troubleshooting

Check: LEDs

The option contains two LEDs to indicate the state of the device and the network. During normal operation the MS and at least one NS LED shows a constant green light.

State	LED	Description
No power	Off	The device is un-powered
Device operational	Green: 	Solid green The device is operational
Standby	Green: 	Flashing green The device needs commissioning
Minor fault	Red: 	Flashing red The device has detected a recoverable fault
Major fault	Red: 	Solid red The device has detected an un-recoverable fault
Self test	Red: 	Flashing red/ green The Modbus TCP option is in self-test mode
	Green: 	
No IP address	Yellow 	Steady yellow No IP address configured or obtained
Wink	Yellow 	Flashing yellow Flash for 20 s

6

Table 6.1 MS: Module Status







State	LED	Description
No IP-address (no power)	Off	No link present (or is un-powered)
Connected	Green: 	Solid green Link present; but nor winked and no ACD
Duplicate IP	Red: 	Solid red The IP-address assigned to the device is already in use
Self test	Red: 	Flashing red/ green The Modbus TCP option is in self-test mode
	Green: 	
Device has been winked	Yellow 	Flashing yellow Flash for 20 s
Link present at 10 Mbps	Yellow 	Steady yellow Link present; but nor winked and no ACD

Table 6.2 NS1+NS2: Network Status (one per port)

Check: Link Status

The status of the Ethernet link cannot be directly identified with the LEDs.

Use 12-10 Link Status, to verify presents of the link.

Use 12-11 Link Duration, to verify that the link is steady present.

The parameter shows the duration of the present link, and preset to 00:00:00:00 if the link is broken.

Check: Cabling

In rare cases of cabling mis-configuration, the option might show the presents of a link, but no communication is running. Exchange the cable in doubt.

Check: IP Address

Verify that the option has a valid IP address (refer to 3.1.1 IP Settings) in 12-01 IP Address. If the option has identified a duplicate IP Address NS LEDs lights steady red. If the option is set up for BOOTP or DHCP, verify that a BOOTP or DHCP server is connected in 12-04 DHCP Server.

If no server is connected, the parameter shows: 000.000.000.000.

6.2 Alarm Word and Warning Word

Alarm word and warning word are shown in the display in Hex format. If there is more than one warning or alarm, a sum of all warnings or alarms is shown. Warning word and alarm word are displayed in 16-90 Alarm Word to 16-95. For more information on the individual alarms and warnings, refer to the product relevant Design Guides.

NOTICE

The availability of the individual alarms and warnings are dependent on the frequency converter type.

Warning and Alarm Messages

There is a clear distinction between alarms and warnings. If there is an alarm, the frequency converter enters a fault condition. After the cause for the alarm has been cleared, the master must acknowledge the alarm message in order to start operation of the frequency converter again. A warning, on the other hand, may appear when a warning condition arises, then disappear when conditions return to normal without interfering with the process.

Warnings

All warnings within the frequency converter are represented by a single bit within a warning word. A warning word is always an action parameter. Bit status [0] *FALSE* means no warning, while bit status [1] *TRUE* means warning. Each bit status has a corresponding text string message. In addition to the warning word message, the master also notifies via a change in the status word.

Bit (Hex)	Alarm word 2 (16-91 Alarm Word 2)
00000001	Service Trip, Read/Write
00000002	Reserved
00000004	Service Trip, Typecode/ Sparepart
00000008	Reserved
00000010	Reserved
00000020	No Flow
00000040	Dry Pump
00000080	End of Curve
00000100	Broken Belt
00000200	Discharge high
00000400	Start failed
00000800	Speed limit
00001000	Reserved
00002000	Reserved
00004000	Reserved
00008000	Reserved
00010000	Reserved
00020000	KTY error
00040000	Fans error
00080000	ECB error
00100000	Reserved
00200000	Reserved
00400000	Reserved
00800000	Reserved
01000000	Reserved
02000000	Reserved
04000000	Reserved
08000000	Reserved
10000000	Reserved
20000000	Reserved
40000000	PTC thermistor
80000000	Dangerous failure

Table 6.3 Alarm Word 2

Bit (Hex)	Warning word (16-92 Warning Word)
00000001	Brake check
00000002	Power card over temperature
00000004	Earth fault
00000008	Control card over temperature
00000010	Control word timeout
00000020	Over current
00000040	Torque limit
00000080	Motor thermistor over temp.
00000100	Motor ETR over temperature
00000200	Inverter overloaded
00000400	DC link under voltage
00000800	DC link over voltage
00001000	DC link voltage low
00002000	DC link voltage high
00004000	Mains phase loss
00008000	No motor
00010000	Live zero error
00020000	10 V low
00040000	Brake resistor power limit
00080000	Brake resistor short circuit
00100000	Brake chopper fault
00200000	Speed limit
00400000	Fieldbus comm. fault
00800000	24 V supply fault
01000000	Mains failure
02000000	Current limit
04000000	Low temperature
08000000	Voltage limit
10000000	Encoder loss
20000000	Output frequency limit
40000000	Safe stop
80000000	Extended status word

Table 6.4 Warning Word

Bit (Hex)	Warning word 2 (16-93 Warning Word 2)
00000001	Start Delayed
00000002	Stop Delayed
00000004	Clock Failure
00000008	Firemode was active
00000010	Reserved
00000020	No Flow
00000040	Dry Pump
00000080	End of Curve
00000100	Broken Belt
00000200	Discharge high
00000400	Reserved
00000800	Reserved
00001000	Reserved
00002000	Reserved
00004000	Reserved
00008000	Reserved
00010000	Reserved
00020000	KTY warning
00040000	Fans warning
00080000	ECB warning
00100000	Reserved
00200000	Reserved
00400000	Reserved
00800000	Reserved
01000000	Reserved
02000000	Reserved
04000000	Reserved
08000000	Reserved
10000000	Reserved
20000000	Reserved
40000000	PTC thermistor
80000000	Reserved

Table 6.5 Warning Word 2

Bit (Hex)	Extended status word (16-94 Ext. Status Word) FC 202 only !!
00000001	Ramping
00000002	AMA Running
00000004	Start CW/CCW
00000008	Slow Down
00000010	Catch Up
00000020	Feedback high
00000040	Feedback low
00000080	Output current high
00000100	Output current low
00000200	Output frequency high
00000400	Output frequency low
00000800	Brake check OK
00001000	Braking max
00002000	Braking
00004000	Out of speed range
00008000	OVC active
00010000	AC brake
00020000	Password Timelock
00040000	Password Protection
00080000	Reference high
00100000	Reference low
00200000	Local Ref./Remote Ref.
00400000	Reserved
00800000	Reserved
01000000	Reserved
02000000	Reserved
04000000	Reserved
08000000	Reserved
10000000	Reserved
20000000	Reserved
40000000	Reserved
80000000	Reserved

Table 6.6 Extended Status Word

Bit (Hex) FC 200	Extended status word 2 (16-95) FC 202 only !!
00000001	Off
00000002	Hand/Auto
00000004	PROFibus OFF1 active
00000008	PROFibus OFF2 active
00000010	PROFibus OFF3 active
00000020	Relay 123 active
00000040	Start Prevented
00000080	Control ready
00000100	Drive ready
00000200	Quick Stop
00000400	DC Brake
00000800	Stop
00001000	Stand By
00002000	Freeze Output Request
00004000	Freeze Output
00008000	Jog Request
00010000	Jog
00020000	Start Request
00040000	Start
00080000	Start Applied
00100000	Start Delay
00200000	Sleep
00400000	Sleep Boost
00800000	Running
01000000	Bypass
02000000	Fire Mode
04000000	Reserved
08000000	Reserved
10000000	Reserved
20000000	Reserved
40000000	Reserved
80000000	Reserved

Table 6.7 Extended Status Word 2

Index

A
Abbreviations..... 4
Alarm Word..... 37
Assumptions..... 3

B
Background Knowledge..... 3

C
Cabling..... 33, 37
Configuration..... 27, 28, 32, 4
Control WordPROFdrive Profile (CTW)..... 19
Conversion Index..... 35, 36

D
Data Type..... 35
DC Backup..... 3
DeviceNet..... 3

E
EMC Precautions..... 10
Ethernet..... 10, 11, 15, 31, 33, 35, 37

F
Frequency Converter Profile..... 25, 24

H
Hardware..... iii, 3

I
I/O..... 4
IGMP..... 15, 33
Installation..... iii, 3

IP
 Settings..... 11, 35
 Traffic..... 15
IP21/Type 1..... 3

L
LED..... 4, 6
LEDs..... 37
Literature..... 3

M
Master..... 38

Modbus

Conformance..... 3
Exception Codes..... 18

N
Network..... 3, 10, 15, 31, 33, 37, 6, 8

O
Overview..... 5

P
Parameter Values..... 18
Parameters..... iv, 11
Profibus..... 3
PROFdrive State - Transition Diagram..... 21

R
Reference..... 23, 24, 25, 4, 23, 40

S
Safety..... iii
Spanning Tree..... 4, 15
Status WordPROFdrive Profile (STW)..... 20

T
Topology..... 7, 8, 15, 7

W
Warning Word..... 39, 37



www.danfoss.com/drives

Danfoss can accept no responsibility for possible errors in catalogues, brochures and other printed material. Danfoss reserves the right to alter its products without notice. This also applies to products already on order provided that such alterations can be made without subsequential changes being necessary in specifications already agreed. All trademarks in this material are property of the respective companies. Danfoss and the Danfoss logotype are trademarks of Danfoss A/S. All rights reserved.

